

Emotec D Emotec H

Sauna control unit

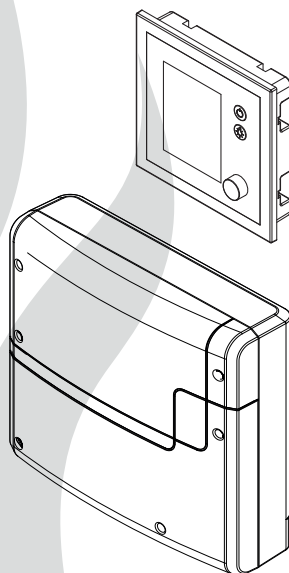

GB

Installation and operation manual

NOT FOR END CONSUMERS!

Made in Germany



English

Contents

Scope of delivery	4
Accessories	4
Technical data.....	5
General information about sauna bathing	6
General safety precautions	7
Installation	9
Main electronic unit (relay box).....	9-10
Control panel - location and cable connections	11
Control panel - flush-mounted installation.....	12-13
Installation of the temperatur sensor.....	14-15
Electrical connections.....	16
Connection of the sauna heater.....	16
Connection of the sauna lighting.....	17
Connection of the power extension unit (LSG)	17
Installation diagram and terminal block overview.....	18-19
Temperature sensor	20
Humidity sensor	20
2nd temperature sensor (bench sensor).....	20
Connection scheme overview (Emotec D and H).....	21
Connection of the vaporizer	22
Installation and connection of the humidty sensor	22
Installation and connection of the 2nd temperature sensor	23
Setup (commissioning / first switching)	24
Language setting.....	24
Time and date setting	24
Basic setup (type of use, type of heater, safety).....	24
Operation	26-36
Overview	26
Symbol description (main navigation menu).....	27
Symbol description (additional settings).....	28
Graphic user interface.....	29
Monitoring of climate conditions.....	29
Operation and settings (main functions).....	30-33
Operation and settings (additional functions).....	34-36
Service-Level (setup and settings)	37-40

Setup level access and graphic user interface	37
Symbol description	38
Description of settings.....	39-40
Troubleshooting (error messages)	41
Main switch (Switch-off).....	42
Service address	43
Warranty information	43
Handling procedures for return shipments (RMA) - details for all returns	44

Scope of delivery

(changes are reserved)

1. Main electronic block (with two-part front cover)
2. Control panel with colour display
3. Housing base for flush-mounted installation of the control panel, with mounting brackets
4. De-installation tool (for control panel)
5. Temperature sensor: a) housing, b) sensor board, c) overheat protection fuse, d) 2 mounting screws 4 x 40 mm, e) connection cable 5 m with RJ10 plug, f) 2-core white cable for overheat protection fuse 5 m
6. Connection cable (control panel - main block) with RJ14 / RJ10 plugs
7. Plastic bag with 3 mounting screws 4 x 25 mm (for main block)
8. 1 spare overheating protection fuse
9. 5 rubber cable glands
10. 1 installation & operation manual, 1 operation manual (for end users)



Accessories (optionally available):



2nd sensoritem 94.5725 (only for Emotec D and H)



Humidity sensoritem 94.5726 (only for Emotec H)

Technical data

Voltage (power supply):	400 V 3 N AC 50 Hz
Switching capacity:	max. 9 kW resistive load, may be extended with a power extension unit (LSG)
Heating time limit:	6 h / 12 h / unlimited*
Housing:	plastic, shatter-resistant
Display:	TFT colour display 55 x 74 mm (3,5" size)
Operation:	2 direct buttons for On/Off and light, jog-dial switch
Temperature control range:	30° - 110°C (dry sauna mode) 30° - 70°C (humid sauna mode - only Emotec H)
Humidity control:	proportional to time or optionally as per rel. air humidity (%) with an optional humidity sensor.
Sensor system:	Digital sensor with overheating protection fuse (STB) 142°C
Control characteristic:	Digital two-point control
Connection for fan:	min. 5 W, max.150 W (only fans without starting capacitor)
Connection for light:	min. 5 W (20 mA), resistive loads - max. 150 W, dimmable energy saving lamps - max. 35 W Lamps at conventional transformers - max. 60 VA. Attention: only dimmable lamps may be used!
	 Fan and light output are protected together with one 5AT fuse.
Start time pre-selection:	up to 24 h in advance
Switching automation:	Week timer with 4 switching programs per day
Error display:	Clear text error indication on the display
Outputs:	3 x RJ10 jacks for sensor connections 2 x RJ14 jacks for control panel and extension modules 1 x potential free contact (2 terminals)
Card reader:	Micro-SD card reader in control panel
Ambient temperatures:	-10°C to +35°C
Storage temperatures:	-20°C to +60°C
Dimensions main block:	H 270 x W 300 x D 100 mm
Dimensions control panel:	H 127 x W 130 x D 25 mm (flush-mounting) recessed part 20 mm deep

* By „unlimited“ setting the heating time will be up to 98 h 59 min for safety reasons.

Dear customer

You have purchased a high-quality technical device with which you will have years of sauna fun. This sauna control unit was designed and inspected according to the current European safety standards and manufactured at the factory in accordance with the quality management standard DIN EN ISO 9001:2000.

This detailed installation and operation manual has been prepared for your information. Please observe in particular the **important notes** and the information on electrical connection.

We wish you exhilarating recreational experience and lots of fun with your sauna!

Intended use

This sauna control unit is exclusively intended for the control of the sauna heater in a sauna cabin.

Any other use over and above the intended purpose is not considered as appropriate use! Compliance of the standard operation, maintenance and repair conditions is also an element of appropriate use.

The manufacturer cannot be held liable for deviating, unauthorized alterations and any resulting damages: the initiator of these changes bears the full risk.

General information

Please check whether the unit has arrived in perfect condition. Any transport damages should be immediately reported to the freight forwarder delivering the goods or you should contact the company that shipped the goods.

Please note that you will only be able to achieve an optimum sauna climate if the cabin with its air intake and ventilation, the sauna heater and the control unit are aligned to each other.

Please observe the information and stipulations made by your sauna supplier.

Sauna heaters heat up your sauna cabin using heated convective air. Here, fresh air is drawn in from the air intake which, when heated, rises upwards (convection) and is then circulated within the cabin. Part of the used air is pushed out through the vent in the cabin. This creates a typical sauna climate which can achieve temperatures of approx. 110°C measured directly under the ceiling of your sauna, dropping in temperature to approx. 30-40°C towards the floor. It is therefore not unusual to measure temperatures of 110°C on the temperature sensor hanging over the heater, whilst the thermometer hanging on the sauna wall, approx. 20-25 cm under the cabin ceiling, only indicates 85°C. The bathing temperature generally lies between 80°C and 90°C in the area of the upper bench when the temperature is set to maximum.

Please note that the highest temperatures are always generated over the sauna heater and that the temperature sensor and the safety limiter must be mounted there in accordance with the control unit installation instructions.

When heating up for the first time, you may notice a slight smell caused by evaporating lubricants used in production processes. Please ventilate your cabin before beginning your sauna bath.

General safety precautions

This device can be used by children aged 8 upwards and by persons with physical, sensory, or mental disabilities, or who have inadequate experience and knowledge if they are supervised or if they have received adequate instruction in how to use the device safely and understand the associated risks. Children may not play with this device. Children may not clean or carry out any user maintenance if unsupervised.

Children are to be supervised in order to make sure that they do not play with this device.

 **Attention:** It is forbidden to install the control box in a closed switch cabinet or behind a wooden panelling!

The electrical installation may be done only by a qualified electrical technician.

You must comply with the regulations of your power supply company and applicable VDE regulations (DIN VDE 0100).

 **WARNING:** Never attempt repairs or installations yourself, as this could result in serious injury or death. Only a qualified technician may remove the housing cover.

Please note the dimensions in the assembly instructions, especially when installing the temperature sensor. The temperature above the oven is critical for the temper-

ature setting. The temperature can be held within operating parameters and a minimal temperature gradient inside the bench area of the sauna cabin can be achieved only if unit is assembled correctly.

The device may only be used as intended as a control unit for sauna ovens up to 9 kW (up to 36 kW when combined with a contactor box).

Completely disconnect the control unit from the electrical circuit, i.e. flip all circuit breakers or the main circuit breaker during each installation or repair.

Please note the safety and installation information from the sauna oven manufacturer.

Always heed the specifications and instructions of the cabin manufacturer, too.



When using control units that offer the possibility of external access (GSM-module, remote button, etc.) or time-delayed switching (preselection time, weekly timer, or similar) a trigger guard with covered heating unit is required. (cover protection type 1-5 or S-Guard).



Attention!

Dear customer,
according to the valid regulations, the electrical connection of the sauna heater and the control box has to be carried out through the specialist of an authorized electric shop

We would like to mention to the fact that in case of a warranty claim, you are kindly requested to present a copy of the invoice of the executive electric shop.

Installation of the main electronic block

The main electronic block (relay box) may be installed only outside sauna cabin. The recommended places of installation are the outer sauna wall or a plant room (technical room). The installation on the sauna roof is also possible. If empty ducts for connection cable are already available, then they usually predetermine the installation position. The installation shall be carried out as follows:

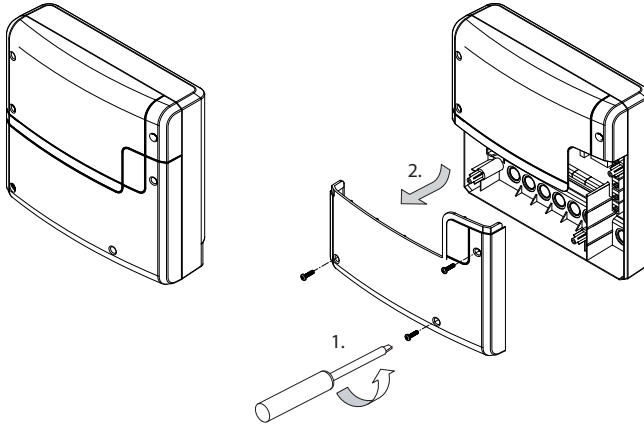

Fig. 1

1. Take the lower part of the front cover off the relay box. For this undo 3 fixation screws, then pull the cover slightly downwards and take it off. See the fig. 1 for details.
2. The relay box has three mounting holes on the rear side. Refer to fig. 2 below for dimensions in order to mark the position on the wall (template). The central upper screw shall be used to hang the relay box onto it with the corresponding opening on its rear side. Two lower screws shall be used to secure the housing to the wall after it is hanged on the upper screw.

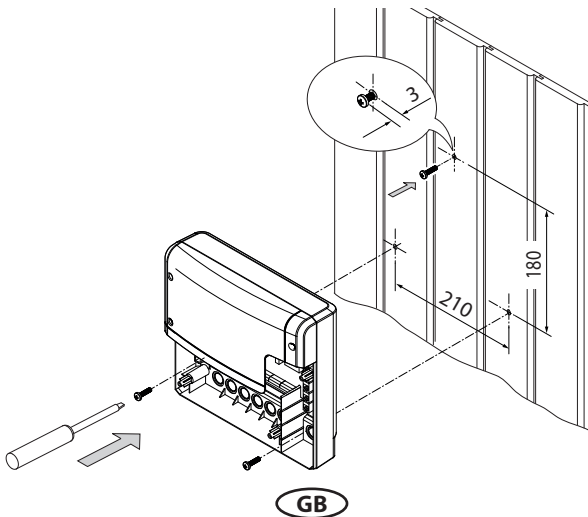

Fig. 2

3. Hang the housing on the central upper screw. Make sure that this screw stands out approx. 3 mm from the wall surface. If the connection cables shall be connected from the rear, knock out the corresponding openings in the housing and insert the supplied cable glands (rubber cable holders) into these openings. Pull the cables through them into the housing.

Secure the housing with two mounting screws 4x25 mm through the corresponding holes as shown on fig. 3 below.

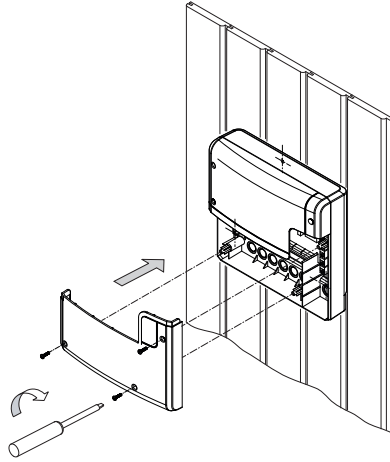

Fig. 3

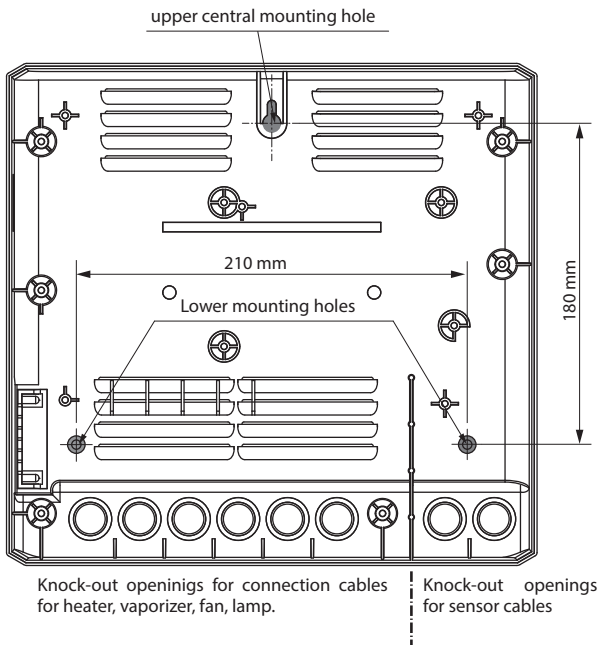

Fig. 4

Control panel

Installation place

The control panel may only be mounted outside the sauna cabin. If ductwork is already provided for electrical installations then the position of the control unit is predetermined by that. The control panel is designed for flush-mounted installation into the sauna wall or a similar adjacent wall. The installation shall be carried out as follows.

First of all determine the installation position. Ideally it should be at the eye sight height, as shown on fig. 5

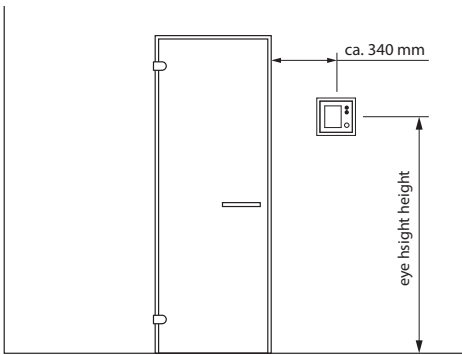

Fig. 5

Make a cut-out in the wall with dimensions 117 mm height x 120 mm width.

Be careful not to make it too large, the flange of the control panel has 5 mm.

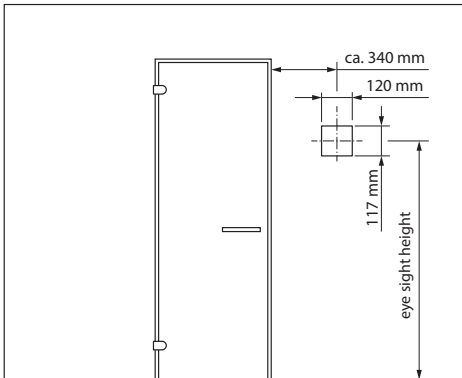

Fig.6

Cable connection

Draw the connection cable from the relay box to the control panel.

The connection cable may be laid only between the outer sauna wall and insulation layer to prevent overheating (Fig. 7).

The insulation should ensure that the temperature at the outer sauna wall may not exceed 75° C.

Pay attention to that the bigger plug (RJ14) shall be oriented towards the relay box and the smaller plug RJ10 towards control panel.

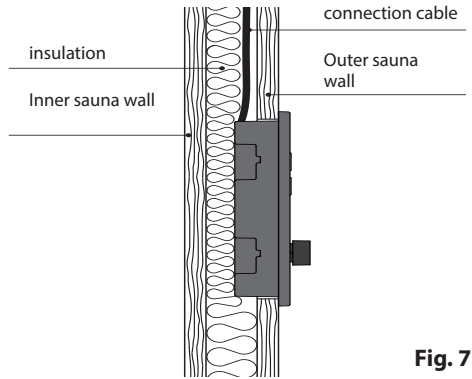
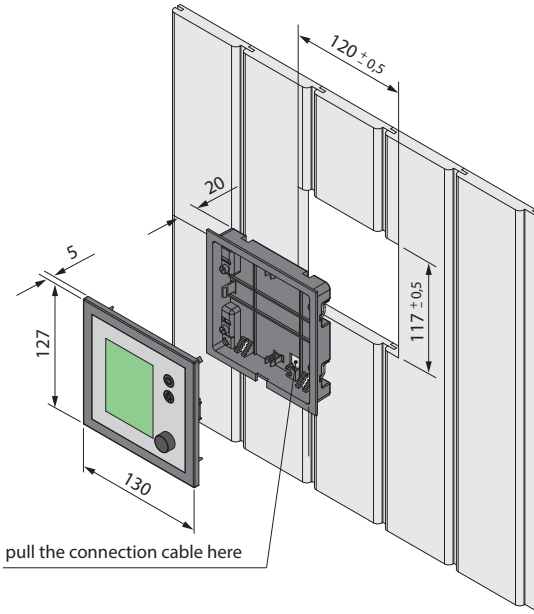

Fig. 7

Use the supplied 5 m connection cable with RJ10 plug (control panel side) and RJ14 plug (relay box side).

If necessary this connection line may be extended to approx. 100 m length. For this you will need to use a standard coupling RJ14/RJ14 and the extension cable with RJ14 plugs in required length. The coupling and extension cable may be purchased from specialist dealers.

Flush-mounted installation



Wall aperture:
Width 120 mm
Height 117 mm
Depth min. 20 mm

Advice:
Pay attention to the correct orientation of the housing base, the opening for connecting cable should be at the bottom side as shown on fig. 8

Fig. 8

Installation of the housing base

First install the housing base (wall paneling up to 30 mm).

1. Loose 4 screws with mounting brackets on the base
2. Adjust the brackets to the designated wall paneling thickness (<15 mm or 15-30 mm)
3. Pull the connection cable through the opening in the housing base.
4. Insert the housing base into the wall opening.
5. Flip the brackets 90° to outside and tighten the screws - the housing base will be pulled to the wall paneling from inside and fixated in the wall opening.

By wall paneling < 15 mm (factory default)

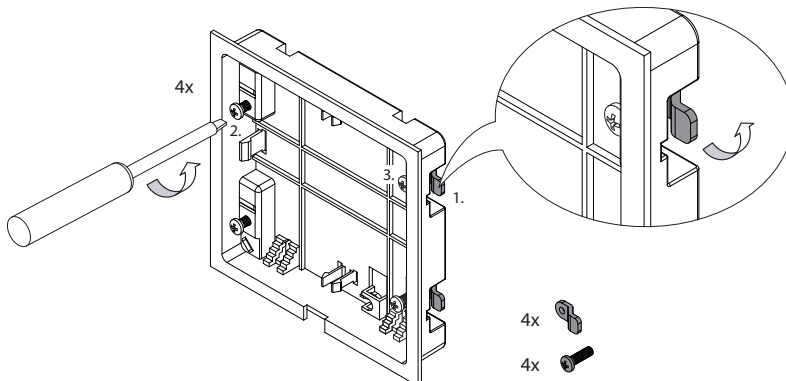

Fig. 9

By wall paneling 15 - 30 mm

turn the brackets around

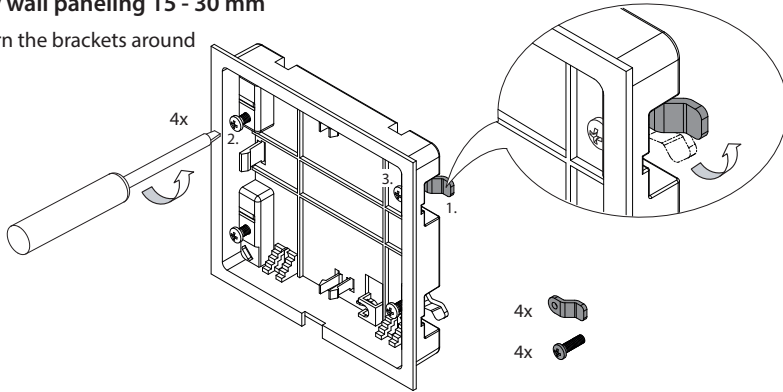

Fig. 10

By wall thickness > 30 mm

Leave the brackets in original position and mount the housing through the mounting holes in the bottom using 4 screws.

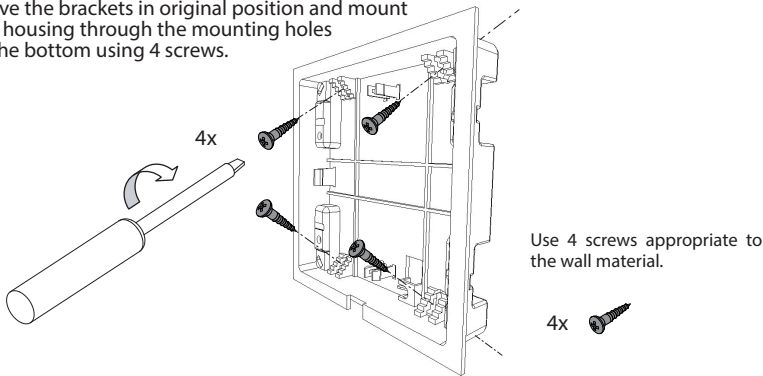

Fig. 11

Installation of the housing upper part (control panel with display)

Place the control panel directly in front of the housing base and pay attention to the correct orientation (jog-dial switch shall be at the bottom right). Plug in the connection cable with RJ10 plug which you pulled through the housing base.

Now press the control panel carefully into the housing base until you hear a click sound (hooks of the upper part should snap into the holders in the base). Make sure the control panel sits reliably in the base part.

Installation hint: When you lay the connection cable do not pull it too tight, allow some extra length around the base, so that later you can take the control panel out of the base easily while still having it connected.

Taking control panel out

To remove (detach) the control panel use the included deinstallation tool or a suitable flathead screwdriver. Insert the tool or screwdriver into the groove located in the middle of the bottom side (between housing upper part and housing base) and carefully pull it away from the wall until control panel is released from the base and may be taken out. Do not apply excessive force as this may damage the inner holders.

Connection of sensor cables

You should not install sensor and power supply lines together, or lead them through the same feedthrough. This can lead to interferences in the electronics, such as “fluttering” in the relays. Connect the cable shielding (if present) to ground in the control unit.

Please observe that the following dimensions relate to the values stipulated during the unit inspection acc. EN 60335-2-53. The heater sensor must always be installed at the point where the highest temperatures are to be expected. Fig. 12-14 provide you an overview of the mounting point of the sensor.



Installation of the temperature sensor

Make sure that there is no deviating mounting position of the sensor, specific to the sauna heater (check the installation guide of the sauna heater).

1. Mount the heater sensor in cabins up to 2 x 2 m according to fig. 12 and 13, in larger cabins according to fig. 12 and 14.
2. Drill a hole to lead the cable through, preferably through the middle of one of the wooden planks.

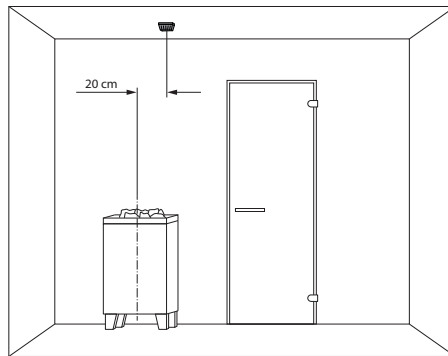

Fig. 12

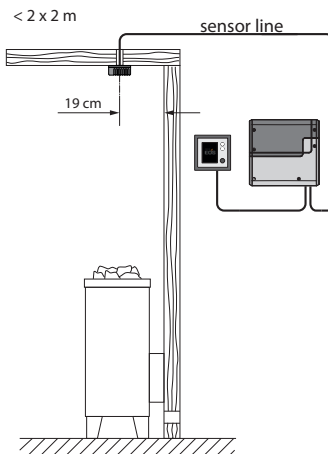

Fig. 13

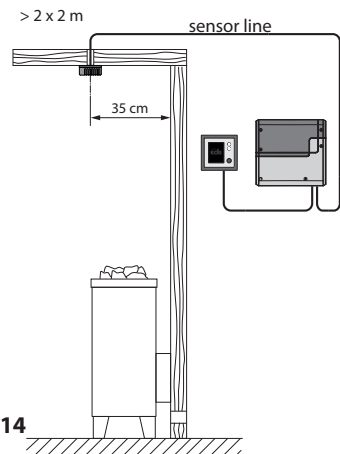

Fig. 14

3. Lead the sensor cable (black) and the limiter cable (white) through the drilled hole and connect both cables to the main relay box as advised on page 20.
4. Connect the sensor cable to the sensor board according to fig. 16. Make sure the connections are correct. Connect the limiter cable (2-core white cable) to the limiter board (STB).
5. Mount the sensor to the ceiling plank using two supplied screws and attach the housing cover.
6. After completed installation and correct commissioning of the control unit, the sensor line for overheating protection must be tested for proper functioning. Disconnect one of the wires of the white cable at the STB board in the sensor housing - the respective error message shall appear on the display. Re-connect the wire to make the error message disappear.

Temperature sensor - connections:

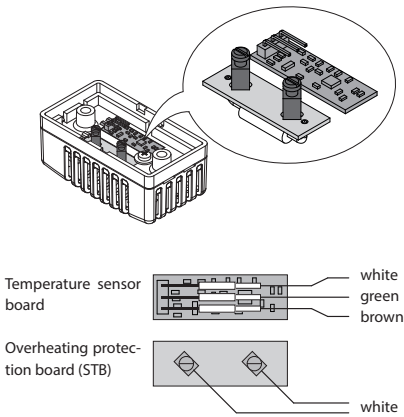

Fig. 16

Temperature sensor - installation overview:

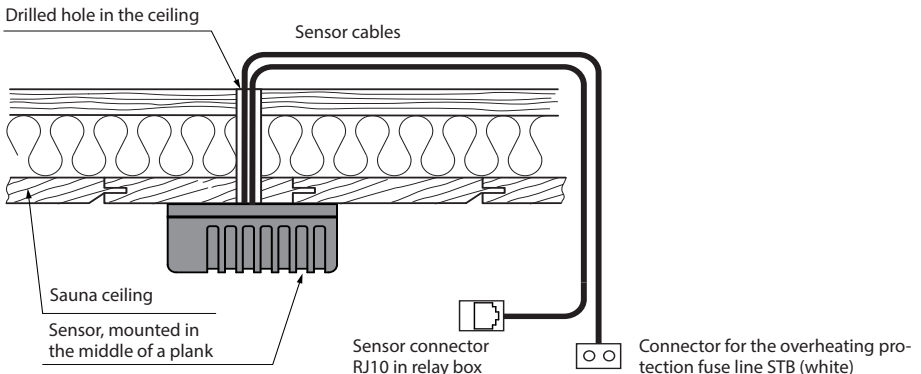

Fig. 17

Electrical connection

The electrical connections may only be carried out by a certified electrician in compliance with the guidelines of the local power supply company and applicable legal regulations (e.g. VDE norms for Germany)..

In general, there may be only one permanent connection line to the network. Furthermore equipment should be provided that makes it possible to disconnect the system on all phases from the power supply with a contact gap of minimum 3 mm.

All electrical installations and all connection lines that are installed inside the sauna cabin must be suitable for an ambient temperature of at least 170 °C.

The power supply line shall be laid to the control unit and connected to the power input terminals.



Leistungsteil, Unterteil der Frontabdeckung geöffnet

Abb. 18

Sauna heater connection



Install the sauna heater and the vaporizer in front of the air intake according to the manufacturer's installation instructions.

Draw the silicone cable through the ductwork to the relay box and connect it to the appropriate terminals as directed in the wiring diagram.

Make sure to observe the wiring diagrams on pages 18 - 19 with the corresponding terminal connection scheme.

Notice: In case there is no ductwork available drill a hole next to the air intake opening and run the heater line through this hole to the outside and to the appropriate terminals in the control unit. The silicone line must be buried to protect it from outside influences. Therefore, use a suitable cable-duct or a PVC-pipe through which you can run the line up to the power unit.

Special advice for connection of Bi-O sauna heaters to EMOTEC H

Attention!

By working vaporizer the sauna heater line „W“ will be diverted to the „Wb“ line of the vaporizer.

The sauna heater section will then operate with 2/3 of the total power.

The power supply cable shall be laid to the main relay box and connected to the power input terminal as per connection diagram (see wiring diagrams, page 18-19).



Sauna lamp connection



The sauna lamp must have the protection class of at least IPx4 and should be resistant to the ambient sauna temperatures. The sauna lamp may be installed at any location but never close to the rising hot air of the heater.

Only dimmable illuminants may be used. The control unit will detect the strongly inductive loads and will adjust the phase edge control accordingly.

Notice: By connection of not dimmable illuminants there is a risk of damaging either the illuminant or the control unit. No warranty claims may be accepted in this case.



Heating time limitation

The maximal heating time may be limited with the jumper #5 on the main board of the relay box. The limitation may be set to 6 hours, 12 hours or to 98 h 59 min.

If the control unit has been set to private (domestic) use, then the heating time will be automatically limited to 6 hours.

The jumper setting will override the software settings.



Connection of the power extension unit

The switching capacity may be extended with an external power extension unit (LSG), in order to connect and operate the sauna heaters above 9 kW power.

For connection details please refer to the installation and operation manual for the respective LSG model.

Installation diagram EMOTEC H

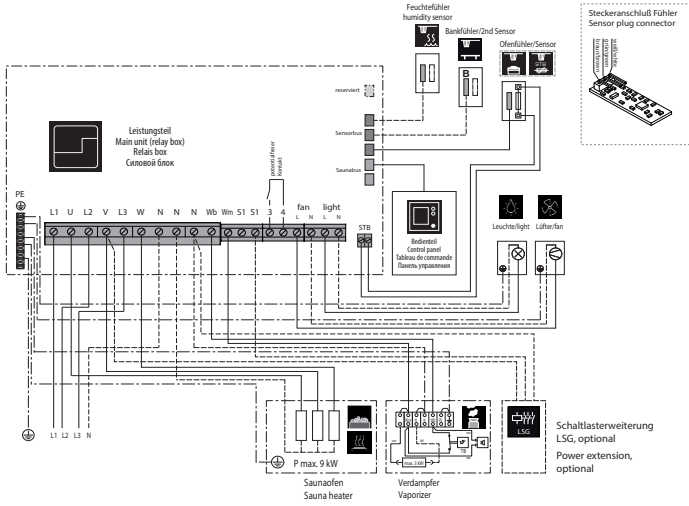

Terminal layout on the main board

(relay box)

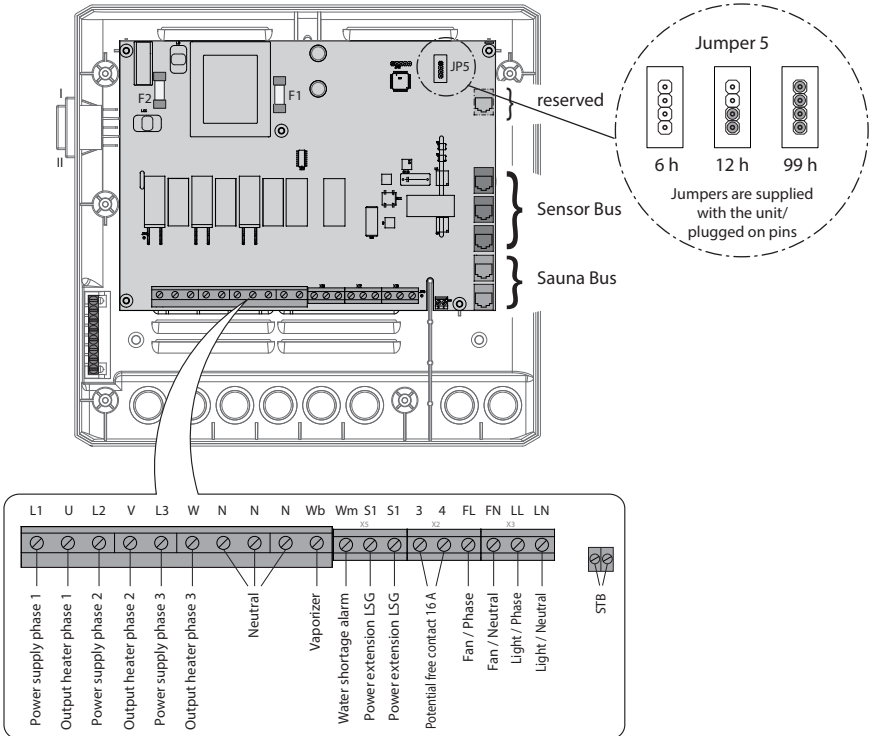

Installation diagram EMOTEC D

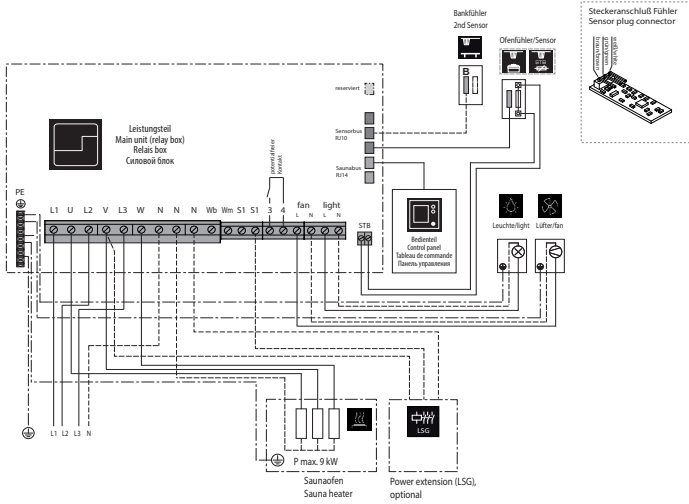

Terminal layout on the main board

(relay box)

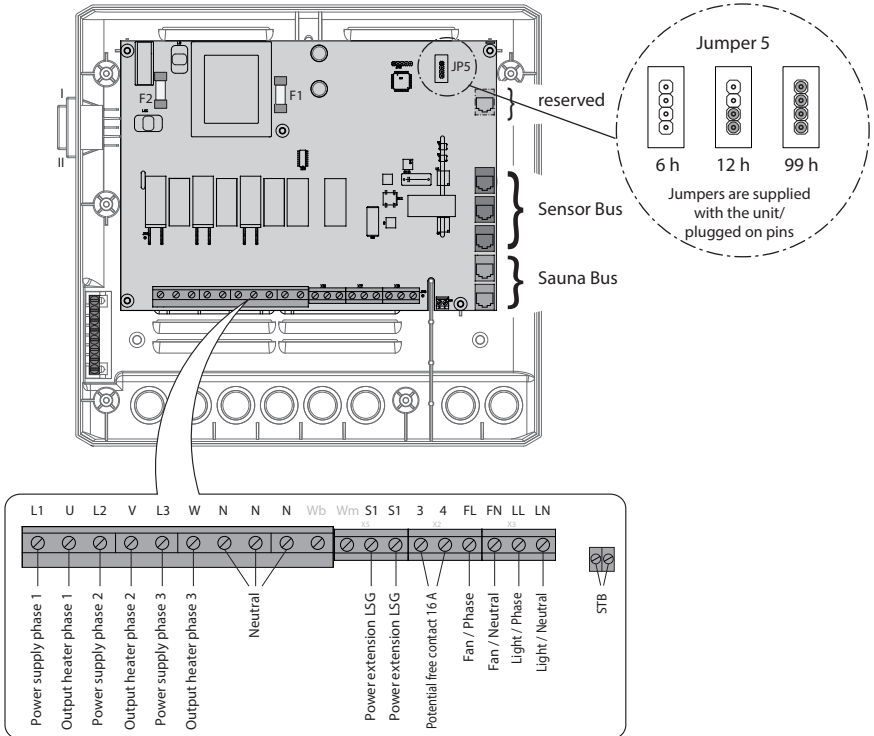

Temperature sensor

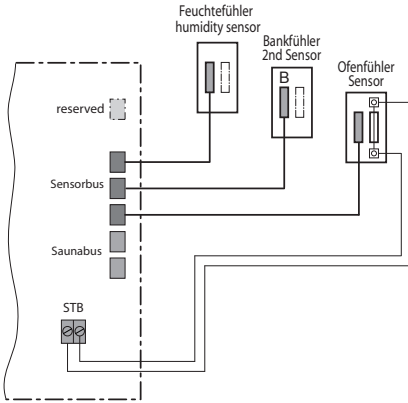

ATTENTION!

Connecting a sensor to the sauna bus connector (RJ14) may damage the sensor and the main board of the control unit!

The sensors are connected via RJ10 modular plugs to one of the corresponding sensor bus RJ10 jacks on the mainboard of the relay box as shown on the left. The connection order may be chosen freely. The sensor bus supports hot-plugging, sensors may be re-connected while the control unit is switched on and will be detected and configured within 2-3 seconds.

The white cable of the overheat protection fuse from the temperature sensor should be connected to the 2-pin STB connector on the mainboard.

Do not try to plug the sensors into the sauna bus connectors (two lower RJ14 jacks), this will damage the sensor and the mainboard.

Humidity sensor (optional, Emotec H)

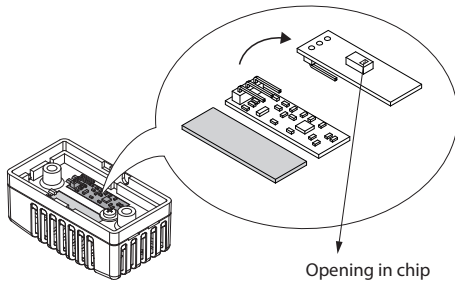

For further details please refer to page 22.

2nd sensor (optional)

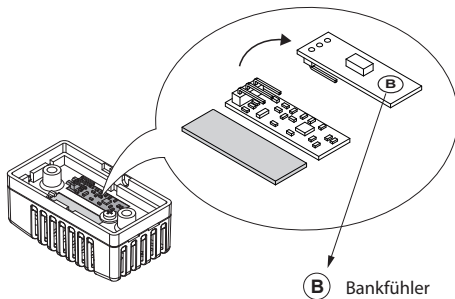

Pin-type connectors in sensor

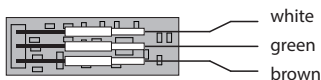

Overview - connections at Emotec D

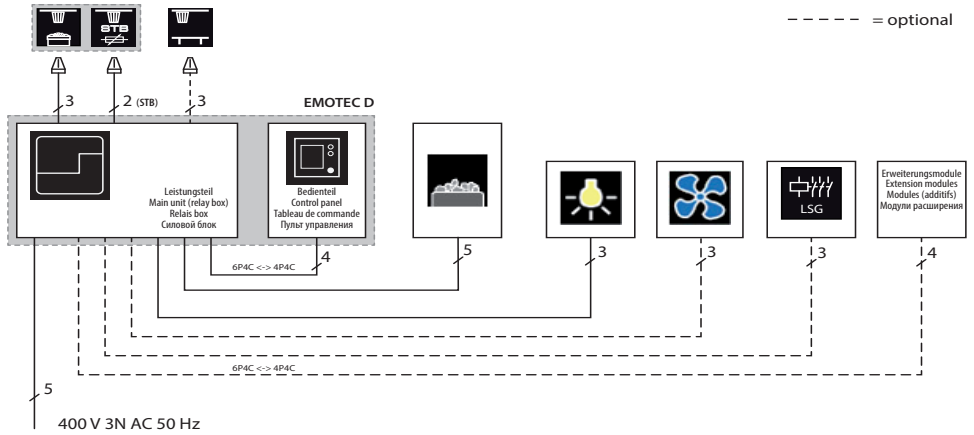

Overview - connections at Emotec H

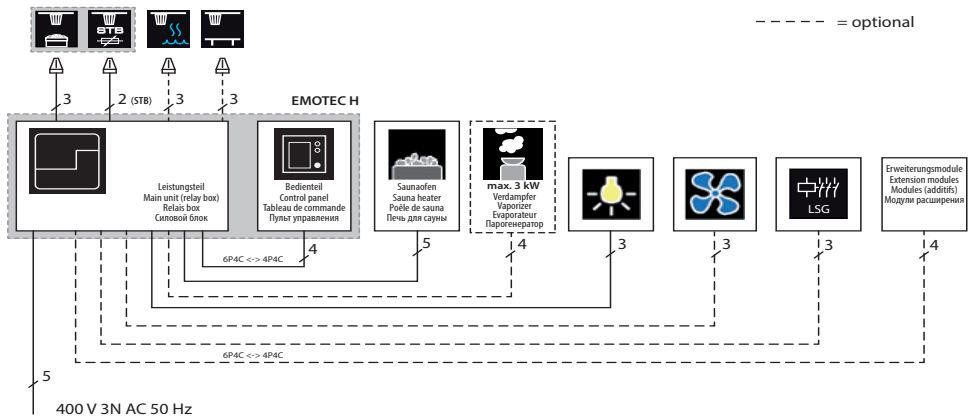

* A control lamp indicating active heating must be installed in the room or location of supervising staff in commercial saunas with disabled heating time limitation..



Vaporizer connection

Only for Emotec H. Use silicone cable 4 x 1,5 mm² for vaporizer connection.



ATTENTION: pay particular attention to the correct connection of the WB and WM terminals. By swapped connection the detection of water shortage in the vaporizer will be disabled and the protective thermo fuse will be bypassed. The vaporizer may overheat! **Risk of fire!**

Fig. 19 shows standard vaporizer connection (EOS models). EOS control units will detect water shortage if there is zero potential at the Wm terminal of the control unit.

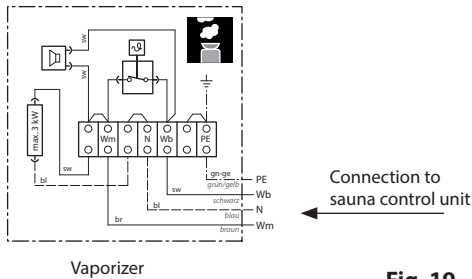

Fig. 19



Attention: Always connect the neutral (N) terminal at the sauna heater. In humid mode one phase will be switched off, the power load distribution will not be proportional. As a result the N line will not be currentless.



Humidity sensor installation (optional)

1. The humidity sensor shall be mounted in the middle of the wall opposite to the heater at approx. 150 cm height.

2. The connection details to the sensor board are shown on Fig. 20.
3. Make sure to connect the cable to the sensor correctly. Incorrect connection may damage the sensor! The sensor cable should be connected via RJ10 plug to the free sensor bus jack in the relay box (as shown on Fig. 20).

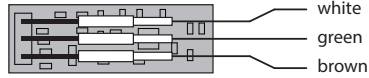



Fig. 20

After connection of the humidity sensor the humidity symbol on the start screen will change



from  to  (in humid operation mode) to indicate humidity control as per relative air humidity. The humidity sensor will be normally detected within 2-3 sec.

Sensors may be connected to any free sensor bus jack (RJ10).

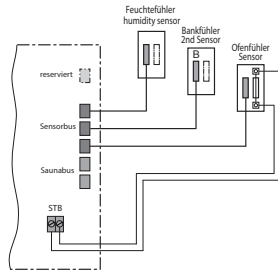
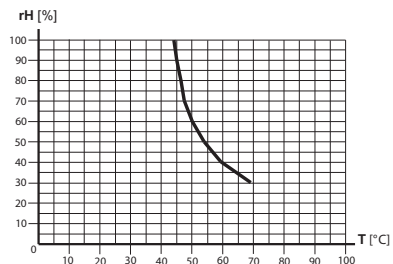

Fig. 21

The humidity control with connected humidity sensor effects basing on the temperature-humidity curve which serves as a limit to possible values. You may set any value to the left and below the curve, e.g. 60°C and 30%.

Temperature/humidity curve as per norm EN 60335-2-53:2003





Installation of the optional 2nd sensor

Place of installation: The 2nd sensor (bench sensor) shall be mounted on the ceiling over the rear bench opposite to the sauna heater (see examples on Fig. 22).

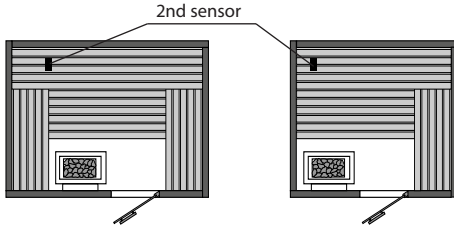

Fig. 22

The bench sensor is connected with a 3-core wire silicone cable with RJ10 plug to one of the free sensor bus jacks in the relay box as shown on the Fig. 23. Cable connection on the board inside sensor are shown on Fig. 24.

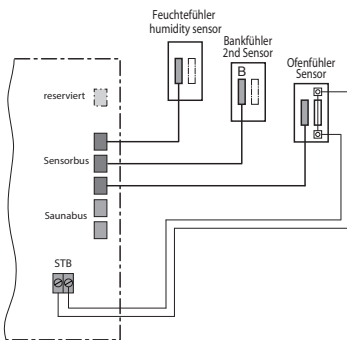

Fig. 23

By correct connection the sensor will be automatically detected and configured. The display will show the following symbol during start-up.

Display symbol:



If the 2nd sensor is faulty the temperature will be controlled via the main sensor over the heater.

After the fault is rectified the 2nd sensor will be automatically detected and configured upon the new start of the control unit.

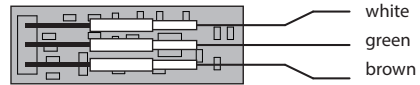
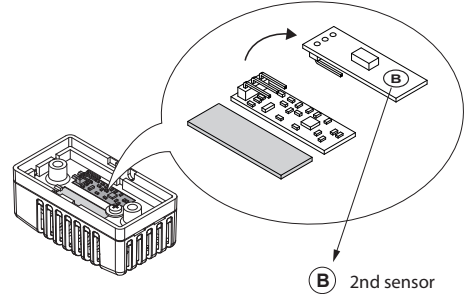

Fig. 24

The 2nd sensor is supplied including 5 m 3-core wire silicone cable with RJ10 plug. This cable shall be connected to the sensor board as shown on the fig. 24. For installation purposes the connection may be easily disconnected (pin-type connectors).

If the 2nd sensor is connected it will be used to control the temperature in the sauna. The main sensor will function only as the overheating protection (142°C limitation).

This allows to improve the air circulation in certain situations, for instance in very large saunas or by complex cabin layouts, and to achieve faster heat distribution to remote parts of the sauna.

Setup (commissioning / first switching)

Using the control unit for the first time or after a reset

The Emotec control unit offers a fast and intuitive setup upon the first switching or after a full system reset.

Step 1 - set language

Choose the required language for menu navigation by rotating the jog-dial knob and press shortly to confirm.

You can choose from 18 languages:

DE, EN, FR, RU, SP, NL, IT, PL, SLO, FIN, TR, CZ, RO, BG, HU, SK, DK, CRO.

Only 9 languages are shown on the display at once, rotate the jog-dial past the last shown option to show hidden languages.



Step 2 - set time

First set the hour by rotating the jog-dial and press shortly to confirm, then set the minutes by rotating the jog-dial and press shortly to confirm.

Step 3 - set date

Set the date, month and year in the same manner.

Step 4 - set the sauna use type

This step configures the essential setup for the sauna use. The control panel will ask several questions and will set the scope of appropriate features according to the selected options.

1. **Is the sauna for private or commercial use?**

Select the applicable option and press to confirm:



for private use, or



for commercial use

2. **Is the sauna installed in the EU?**

Select the applicable option and press to confirm:



- yes, in the EU, or



- no, outside EU.

3. **Safety system as per norm EU 60335 for remote switching / preset timer available?**

Select the applicable option and press to confirm:



- yes, available, or



- no, not available.

4. **Select the heater type (only by Emotec H).**

Select the applicable option and press to confirm:



- dry sauna heater without vaporizer (or with disabled vaporizer)



- sauna heater with vaporizer (Bi-O sauna heater).

The setup is now complete and the control unit will switch to the standby mode.

Notice: if during setup you do not operate the control unit (jog-dial) for more than approx. 5 seconds it will abort the current step and return to the step 1.

Do not press the on/off button during setup, this will abort the setup process and return you to the step 1.

The cabin light switch may be operated during setup, it is independent to the setup process.

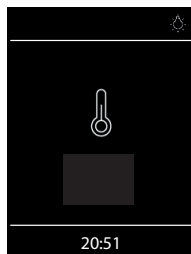

Display in standby mode by dry (Finnish) sauna operation (Emotec D and H).

Cabin light switched on.

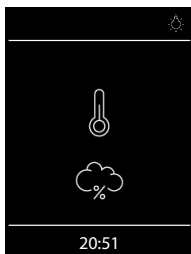

Display in standby mode by humid (Bi-O) sauna operation (Emotec H only).

Cloud symbol appears to indicate the humid mode.

Cabin light switched on.

Operation

Control panel - overview

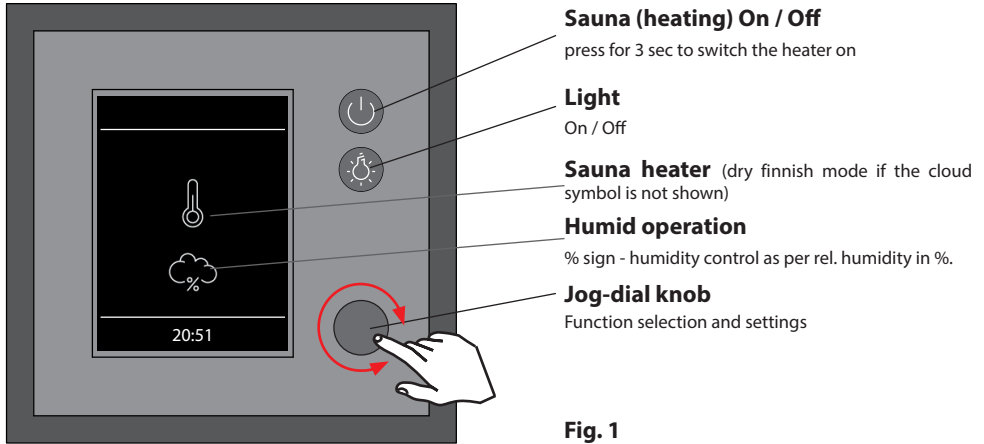

Switching your sauna on / off

In order to switch the sauna heater on press the  button for 3 sec. The sauna will switch on with the preset parameters (e.g. temperature, etc.). To switch off press the button again shortly.

Switching the light on / off

Press the  button on the front panel to switch the light on or off.

Settings

Rotate the jog-dial knob to reach the settings menu. A window as shown on Fig. 2 will open.

By Emotec H models (with enabled vaporizer) the symbol for a quick selection between the dry and humid sauna mode will be shown at the first place.

Settings interface by Emotec H

The symbol for dry or humid mode selection is shown as the 1st option.



Settings interface by Emotec D or by Emotec H with disabled vaporizer.

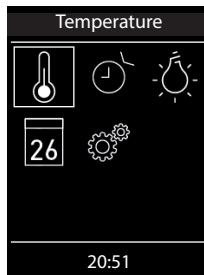

Fig. 2

Hint: if the display of the control panel remains dark after switching the power supply on please check the position of the unit's main switch (Switch-Off rocker switch) located on the main electronics unit (relay box). See chapter "Switch-Off switch" for more details.

Operation principle with a jog-dial knob

Rotate the jog-dial knob to the left or right in order to reach a function. Press shortly on the jog-dial knob to open this function. Rotate the jog-dial knob to change the value (changed value turns from white to green). Press the jog-dial knob shortly to save (confirm) the setting and exit, the control panel will then return to the previous (upper) menu.

Symbol description - main navigation menu



Operation type (only Emotec H)

Selection between dry and humid mode (the vaporizer must be connected and enabled).



Finnish sauna mode

Selection for operation in dry Finnish mode (submenu of the operation type).



Humid sauna mode (Bi-O)

Selection for operation in humid mode. (submenu of the operation type).



Temperature

Setting of the target temperature in the sauna cabin.



Humidity

Setting of the target humidity value in humid operation mode. %-sign indicates a connected humidity sensor (rel. air humidity control).



Auto-Start

Pre-set timer for later automatic switching on of the sauna up to 24 h in advance.



Light

Setting of the desired light intensity and light switching (light dimming 0 - 100%).



Timer

Setting for automatic switching on via calendar. A single event switching or regular week timer switching is possible.



Extended settings

Submenu for further settings. Like e.g. language, time, date, screensaver, child lock, heating time, etc.



Potential-free contact

Switch for the potential-free contact (output).



Back

Return to the upper menu.

Hint:

The on/off switch  on the control panel front functions as a „home“ button during settings and allows you to quickly return to the start screen. Simply press shortly on this button. Please remember that all not yet confirmed settings will be lost in this case.

If you do not operate the jog-dial for more than 20 seconds the control unit will return to the start screen. All not confirmed settings will be lost in this case.

Thanks to the integrated battery (CD2032 type, in control panel) all settings will be stored in the memory and will be retained even in the case of a very long time power loss.

New extension modules and optional equipment will be normally automatically detected and configured. Upon restart the control panel will show the corresponding new symbols in the menu navigation.

Symbol description - extended settings

„Extended settings“ submenu provides a range of additional functions, which normally need to be set only once or quite seldom.

Select the symbol  in the main menu and press shortly on the jog-dial to enter.



Language

Allows to set the language for the menu navigation. 18 languages are available:

DE, EN, FR, RU, ES, NL, IT, PL, SLO, FIN, TR, CZ, RO, BG, HU, HR, SK, DK



Time

Here you can set the time of day.



Date

Here you can set the date, month and year.



Standby mode

Here you can set the interval, after which control panel goes into standby mode.



Screensaver

Here you can set the interval, after which the control panel goes into sleep mode in order to save power. Rotate or press on the jog dial to wake up the unit.



Child lock

Here you can lock the unit with own Pin-code. It will be still possible to switch off the heater and to switch the cabin light.

Please observe the special advice below.



Heating time (Auto-Stop)

Here you can set the desired heating time. By private use - up to 6 hours, by commercial use - up to 12 hours or 99 hours.



Operation data

Here you can check the firmware version, the remaining time until the next service, as well as the contacts for service issues.



Display brightness

Here you can change the display brightness in three steps.



Holiday home mode

Here you can restrict the user's access to the minimum functions with an own Pin-code.



Important advice for Child Lock function

You can completely lock the control panel via  symbol with an individual Pin-code.

By active lock you can only switch off the heater (if it is heating) and switch the cabin light. If you attempt to reach any function you will be prompted to give in the Pin-code.

How to reset the Pin-code:

If you forgot the Pin-code proceed as described to reset it. Press the on/off button or turn jog-dial to initiate the Pin-code prompt, do not change the four „0“ digits, confirm the first „0“ with the jog-dial, the press and hold the jog-dial pressed at the second „0“ (first two zeros turn green, the cursor will move to the third zero).

After approx 40 seconds all zeros will turn white. Now confirm all zeros (do not change them!), the display will return to the start screen and the Child Lock will be reset.

Graphic user interface (GUI) and the current climate conditions query

Thanks to the modern graphic user interface you can quickly access all functions and make necessary settings, as well as make a simple instant query for the current sauna climate condition.

The symbols on the start screen may be displayed in different colours, in order to indicate the current operation status - e.g. white colour for standby and red/blue colour for active heating.

For every selected symbol the control panel will display the meaning of this symbol at the top in one of 18 languages and will provide additional text hints by various settings. For language selection please see the next chapter.

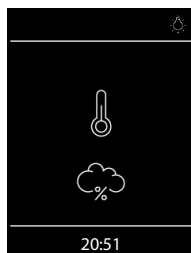

Start screen (standby mode)

In standby mode the display will show the symbol for the heater (thermometer). By Emotec H in humid mode a cloud symbol will be additionally displayed underneath (symbolizes the vaporizer).

The „%“ sign inside cloud means that the humidity sensor has been detected on the control unit (means humidity control as per rel. air humidity).

The light symbol will appear at the top right corner if the light has been switched on. At the bottom the clock will be displayed.

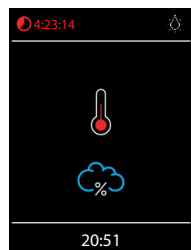

When the sauna is switch on - the thermometer symbol starts to pulse red during the heating up time, after this it will continuously light in red.

The countdown of the remaining heating time will be shown in red at the top left corner. You can stop the heating at any time by pressing on the on/off button shortly.

The blue cloud means the working vaporizer in humid mode. After the humid mode operation, a „sauna-dry“ program will start (up to 30 min, only the heater will run), unless this program has been disabled in setup.

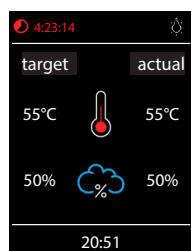

Query for the target and current sauna climate condition

You can quickly check the pre-set (target) and the real temperature (and humidity by Emotec H). Press on the jog-dial for approx. 3 seconds.

The target and current values will be displayed on the screen. The current values correspond to the values measured at the respective sensor.

If the 2nd sensor (bench sensor) is installed, then the current temperature will be shown as measured by this sensor.

Without humidity sensor only the pre-set proportional vaporizer switching will be shown, with humidity sensor the target and the real humidity in % will be shown.

Notice: Please pay attention that the shown values for the current temperature (humidity) are measured at the sensor location point. Because of the considerable differences in temperature in different parts of a sauna these values may vary from the values shown by the instruments mounted at the sauna wall. We recommend to maintain the climate as it is pleasant to you instead of blind orientation on some suggested values.

Operation and program settings



Sauna on / off

Press the  button on the control panel for approx. 3 seconds to switch the sauna on. The display will show active heating state (see previous page). The cabin light will be also switched on.

To switch the sauna off press the  button shortly. By Emotec H models in humid mode the “sauna dry” program will switch on for 30 min. after the main operation. This time may be reduced or the program may be disabled in setup. After this program the sauna will switch off completely.

You can stop the “sauna dry” program at any time - just press the  button again shortly.



Light on / off

Press the light button on the control panel to switch the cabin light on or off. The light will switch on automatically if the heater is switched on, after the heater switches off the light will stay on for 30 minutes.



Sauna operation mode - dry sauna or humid (Bi-O) sauna (only Emotec H)

Select the sauna mode symbol  and press on the jog-dial to enter the selection menu:

select  for the dry Finnish sauna or  for the humid (Bi-O) sauna mode.

If the humid mode has been selected, the humidity symbol will automatically appear in the main menu. This option is only available in Emotec H models.



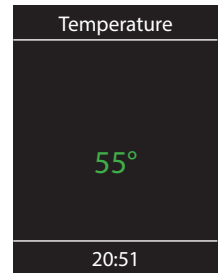
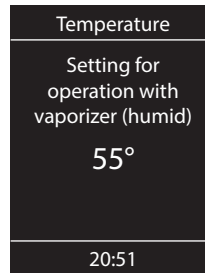

Temperature

Select and press the temperature symbol  in the main menu. A submenu will open and show the current value. Set the new temperature with the jog-dial. Press the jog-dial to confirm and exit. This setting can be also made during active heating.



Humidity (only Emotec H)

Select and press the humidity symbol  in the main menu. A submenu will open and show the last stored humidity value. Set the desired humidity with the jog-dial. Press the jog-dial shortly to confirm the setting and exit. This setting can be also made during active heating (in humid mode).

With a connected humidity sensor (% sign appears inside cloud) the relative air humidity will be controlled. Without humidity sensor the humidity will be controlled in proportional to time way. “30%” then means 30% of the total heating time. The display will show the  symbol.

Please observe that with a humidity sensor the humidity setting will depend on the preset temperature. For safety reasons only the values to the left and under the curve may be selected. For instance at 60°C temperature you can set up to 40% rel. air humidity. In order to set a higher humidity you will need first to reduce the temperature.

If the sauna has been used in dry mode with high temperatures and you switch to the humid mode, the vaporizer will start to work only after the temperature drops under the max. allowed level (70°C)

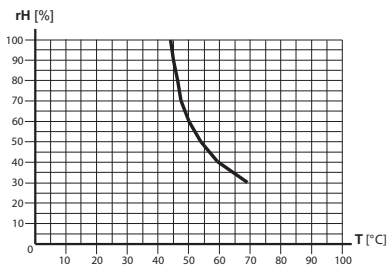

Time pre-selection (Auto-Start)

With this function you can program your sauna to switch on at a later time with up to 24 h delay. In the main menu select and press the timer symbol



with the jog-dial. A submenu will open and display „--:--“. Rotate the jog-dial to set the hour for the desired automatic switch on tim. Press on the jog-dial to confirm and to jump to minutes. Now set the desired value for minutes and press the jog-dial to save the setting and to exit. At the startscreen you will see at the bottom right the blinking timer with the programmed time. This time means the time of day, not the delay in hours/minutes from the moment of setting.

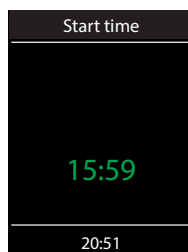

To delete the pre-set Auto-Start timer simply press shortly on the On/Off button. The blinking timer indication shall disappear.



Attention! This function is only allowed to be used if your sauna is fitted with an approved safety system, which prevents the heater from being switched on in unsafe condition (e.g. a towel forgotten on the heater). Even in the case if your sauna has such an approved system, prove there are no objects forgotten on the heater. Risk of fire!



How to dim the cabin light

The light button on the control panel  allows to switch the light on/off quickly. In the main menu you can adjust the light brightness (dim the light 0-100%) over the same symbol.

Press on the  light symbol with the jog dial. The cabin light will switch on (if not yet switched on) and a submenu will open and display the current light setting in %. Rotate the jog-dial to adjust the brightness to the desired value. Press on the jog-dial shortly to confirm the new setting and to exit the submenu.

Please observe that the light dimming will only function if a dimmable transformer or a regular resistive load incandescent bulb has been connected. Make sure to observe the minimum and maximum power load for the connected lamps (see specifications or contact your dealer).



Timer (swith-on time pre-selection)

The timer function allows you to have your sauna switched on automatically with the desired climate condition at some time in the future. You have two possible options:





– single event (single time switching, not recurrent)

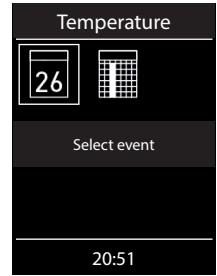

– week timer (regular, recurrent switching for the given day of the week, e.g. Monday, with up to 4 switchings (programs) per day.



Attention! This function is only allowed to be used, if your sauna is fitted with an approved safety system, which prevents the heater from being switched on in unsafe condition (e.g. a towel forgotten on the heater). Even in the case if your sauna has such an approved system, prove there are no objects forgotten on the heater. Especially by active week timer make sure to check your sauna for safe condition regularly. Risk of fire!

For single event switching press on the  symbol in the main menu. In the submenu (see example above) press again on the  symbol for the single event programming.

Now set the day, month and year for the desired switching. Then in the new window set the start time (hours and minutes). Then in the new window set the operation type (dry Finnish sauna or humid sauna). Then as the last step set the preferred temperature and humidity (only by humid mode). The programming window will close after the last step. At the start screen in the bottom right corner you will now see the flashing programmed time (date and time, e.g. 15.01. and 18:30).

If you want to cancel this program just press shortly on the On/Off switch. The flashing date and time indication will disappear. This program will be also automatically cancelled if you switch the sauna manually.

For week timer programming press on the  symbol (week timer). A new window with seven numbered squares will open (1 to 7, 1 = Monday, 2 = Tuesday, and so on).

Notice: white colour means an empty program place. Green colour means there is a program for the given day.

Select a day of the week, for which you would like to assign a program (e.g. „1“ for Monday) and press on the jog dial.

Notice: You can assign up to 4 programs to each day of the week. The max. heating time for each switching is 12 h. A 6 h pause must be observed after 12 h non-stop heating as per legal regulations. The next program may therefore start only after a 6 h break if the previous program duration has been set to 12 h. If you wish a shorter pause, then set the heating time to less than 12 hours.

Furthermore you can assign individual temperature (and humidity by Emotec H) to each program for automated sauna operation. This allows to implement flexible energy management schemes in your



sauna - for instance during peak-off times you may set the sauna to run at lower temperatures with reduced energy consumption, so that it can then reach the full temperature faster at the main time of use.

Now select the program (1 of 4) and press on the jog dial knob.

1. Set the required start time (hours and minutes) - e.g. 9:30.
2. Set the required heating time (hours and minutes) - e.g. 3:30.
3. Set the required operation type - dry Finnish sauna or humid sauna (only Emotec H)
4. Set the required temperature.
5. Set the required humidity (only Emotec H).

After the last step the control panel will return to the week overview. All days with assigned programs will be displayed in green. Repeat the above steps for every new program you may require (max 4 per day). After you return to the main start screen you will see the indication of the next (earliest) switching time flashing in the bottom right corner (e.g. Monday, 9:30).

How to delete or change the week time

In order to delete or change the program open the week timer via the main navigation menu.

1. Select the respective day of the week.
2. Select the respective program number.
3. Make the necessary amendments (start time, heating time, temperature) or...
4. to delete the program, set the start time (hour and minutes) to "00:00" and press the jog dial two times shortly to confirm and exit.
5. The display will return to the week overview.



Notice: By active week timer you will always see the next earliest switching time displayed flashing in the bottom right corner. Also if you programmed several switching times or a combination of the single event switching and week timer switching.



Potential-free contact

With the potential-free contact (output) you can switch an external device up to 16 A on or off. This function has to be enabled in the setup menu and the external device has to be properly connected and configured.

Please observe that the potential-free contact output only provides a switching signal.

In the main navigation menu select the  symbol and press on the jog dial shortly. In the sub-menu you can now select and press on the  (on) or  (off) symbol in order to make the respective switching.

If you cannot find the symbol of the potential-free contact in the main navigation menu please contact your local dealer to have this function enabled.



Extended settings

The submenu „Extended settings“ allows you to make additional settings, which normally need to be set only once or very seldom.

In the main navigation menu select the  symbol and press on the jog dial shortly.



Language

Here you can set the language for the menu navigation and messaging system. Press on the language symbol, in the respective submenu select the required language and press on the jog dial shortly to confirm. All texts will be then shown in the new language. 18 languages are available.



Time (clock)

Here you can set the time of the day (system time). Press on the clock symbol, in the respective submenu set the hours and minutes with the jog dial and confirm each setting by pressing shortly on the jog dial. After the last setting the display will return to the upper menu. The winter/summer time has to be adjusted manually.



Date

Here you can set the date (day, month, year). Press on the date symbol, in the respective submenu set the date, month and year and confirm each setting by pressing shortly on the jog dial. After the last setting the display will return to the upper menu. Thanks to the integrated battery the once set time will be retained even by very long time power disconnection.



Standby mode

This setting defines the period of time after which the control panel will enter the standby mode if no button has been operated. In standby mode the display brightness will be reduced to the minimum and the display will show the current time (enlarged digits). Rotate the jog dial or press on the on/off button shortly in order to return to the start screen.



Screensaver

This setting defines the period of time after which the control panel will enter the sleep mode. In sleep mode the display will be switched off completely. Rotate the jog dial or press on the on/off or light button to wake the control panel. This function is only active if the heater is not switched on.



Child lock / Operation lock

You can lock the control panel with the individual pin-code in order to prevent the unauthorized access.

In order to lock the control panel select the „lock“ symbol and press on it with the jog dial shortly. A submenu will open and display „0000“. You can now replace the zeros with your personal 4-digit

pin code. Rotate the jog dial to select a number, press on the jog dial to confirm it and to jump to the next digit.

After the 4th digit confirmation the control panel will return to the start screen and the unit is now locked.

Notice: make sure to remember the pin code!

For safety reasons it is still possible to switch off the heater (interrupt active heating) and to switch the light while the unit is locked. All other functions will be locked.

By an attempt to operate the control panel a pin code prompt will appear.

To unlock the unit rotate the jog dial to in order to call the pin code prompt. Now give in your pin code. The unit is now unlocked.

How to reset the pin code by a locked unit

Launch the pin code prompt (rotate the jog dial). DO NOT change the four zeros, press the jog dial shortly to confirm the first zero, at the second zero press the jog dial continuously (the first two zeros turn green, the cursor is under the third zero).

After approx. 40 seconds all four zeros will turn white. Now simply confirm each zero with the jog dial. After the 4th digit confirmation the display will return to the normal start screen. The control unit is now unlocked and the pin code is reset.



Heating time

Here you can set the required heating time duration for your sauna bath.

By private use the max. heating time is limited to 6 hours. By commercial use the max. heating time may be limited to 6 hours, 12 hours or 99 hours (98:59). This limitation may be set in hardware during the installation and setup (jumper 5 setting)

Press with the jog dial on the  symbol and set the required heating time in hours and minutes. This setting will be then valid for every manual sauna switching. You can of course stop the heating earlier at any moment.

After switching the sauna on the remaining heating time will be displayed as a countdown clock in the upper left corner. So you can check at a glance the remaining heating time of your sauna heater.

Please observe that after the humid mode operation (only Emotec H) the sauna heater will be switched in the „sauna dry“ mode in order to dry your sauna cabin. The default sauna dry mode duration is 30 minutes. This time may be reduced (also the pre-set temperature and fan operation time maybe adjusted) in the setup menu. Please contact your dealer for further details.

The heating time may be changed with 1 minute steps. The minimal heating time is 1 minute.

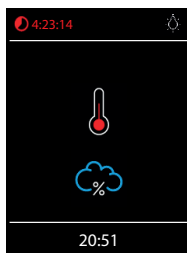



Operation data

Here you can check the important information concerning your control unit (sauna) operation.



Firmware - allows to check the currently installed firmware version. Rotate the jog dial to switch between two possible parameters. „Panel Vx.xx“ - shows the firmware in control panel, „Mod-LS Vx.xx“ - shows the firmware in the main relay unit (x stands for a number). Press on the jog dial to close this submenu.



Service intervals - allows to check the remaining time until the next pending servicing / maintenance of your sauna. The intervals will be set by your dealer (installer) during the installation and setup.



Contacts - shows you the contact information of the sauna control unit manufacturer or your dealer (installer). This information will be also displayed by faults along with the error messages.



Display brightness

Here you can set the display brightness in 3 stages.



Holiday home mode

With this function you can restrict the access to the control panel with your own pin code down to the bare minimum of functions. All other functions will be disabled and their symbols will not be displayed.

Following settings are possible when the holiday home mode is active:

- Sauna on / off
- Light on / off
- Selection of the operation mode - dry or humid (only by Emotec H)
- Temperature setting
- Humidity setting (only by Emotec H)

To activate the mode press on the  symbol. A pin code prompt window with default „0000“ will open. Set your personal pin code with the jog dial. Rotate the jog dial to select a number and press shortly to confirm it and to jump to the next digit. After the 4th digit the display will return to the start screen and the holiday home mode will be activated.

Hint: To cancel the activation while setting the code press shortly on the main on/off button.

To unlock the control panel rotate the jog dial to reach the main navigation menu. Select the  symbol. Press on this symbol with the jog dial. The pin code prompt window will open („0000“ default display). Give in your pin code to unlock the control panel.

How to reset the pin code by a locked unit

Select the  symbol and press on it with the jog dial for approx. 1 minute. The pin code prompt will open, confirm all four zeros with the jog dial. After the 4th digit the control panel will be unlocked and will return to the start screen. The pin code will be reset.

Service- and Setup

The Emotec D and H models provide an extensive set of features and tools for the setup and fine-tuning of the sauna equipment in order to match the specific sauna cabin situation. **This setup menu is protected with a PIN code and should not be accessible to the end users.**

Hint: a short version of the operation manual without setup and installation is included with every controller. Hand it over to the end client and retain this manual for yourself.

In the main menu select the  symbol and press it with the jog dial for approx. 6 - 7 seconds until a PIN-code prompt window opens.

Your PIN code: **5349**

Please make sure to retain this PIN code at the safe place and do not disclose it to the end clients in order to prevent unauthorized access to the basic setup and safety-relevant features.



Press the jog dial knob for approx. 6 - 7 seconds.

>>

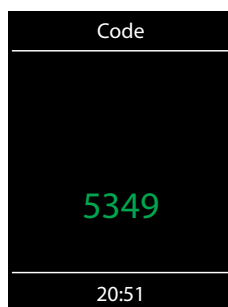

Give in the PIN code

Service & setup level user interface

Depending on the model (D or H) the available functions will be shown as symbols. By Emotec H some symbols will not fit the window and will be hidden. Rotate the jog-dial to scroll and show them on the display.

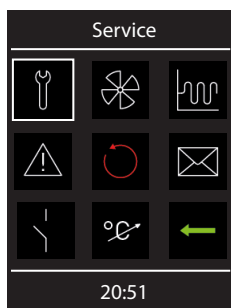

Service level interface of the Emotec D model

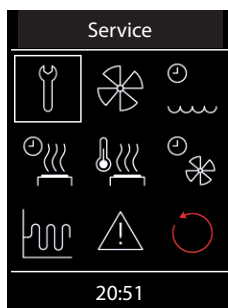

Service interface of the Emotec H model (immediately visible symbols)



Emotec H interface - the lower (hidden) part of the window

Symbol description



Service intervals

Intervals for servicing & maintenance.



Potential-free contact

Enables or disables the potential-free contact switching function.



Fan

Fan speed settings.



Temperature adaptation

Setting for the temperature offset +/- °C.



Refilling time

Grace time to refill the vaporizer (only Emotec H)



back

Exits and returns to the main menu.



Afterheating time

Duration of the „sauna dry“ program after the humid operation (only Emotec H)



Afterheating temperature

Temperature for the „sauna dry“ program in °C. (only Emotec H)



Fan running time

Fan operation time after the humid operation. (only Emotec H)



Hysteresis

Adjustment of the hysteresis curve.



Basic-Setup

Setting of the sauna use type and of the heater type.



Reset

Reset to the factory default settings, all personal settings will be deleted.



Contact details

Displays stored contacts.

Settings



Service intervals

Allows to set the intervals for servicing and maintenance. Upon expiry the control panel will remind the user for a short time upon every switching about the pending servicing. The end user can check the remaining time to the next servicing in the extended settings menu. This function allows as well to keep track of the total operation time of the sauna.

Default setting by domestic use - 500 hours.

Default setting by commercial use - 2500 hours.



Fan

Here you can set the fan operation speed in 3 stages or disable it. If activated, the fan will automatically switch on with the heater (synchronous operation). In „sauna dry“ program the fan will always operate at the highest speed.



Refilling time

Here you can set the grace time which the end user has to refill the vaporizer after the water shortage alarm. If the vaporizer has not been refilled within this time, it will be switched off (overheating protection). This function is especially important for Bi-O heaters with manual refilling.



Afterheating time

Here you can set the time for the „sauna dry“ program after the humid operation. Factory default setting is 30 minutes. After every humid operation the sauna will then switch on in dry Finnish mode in order to dry the cabin. We recommend to use this function in combination with the exhaust fan in order to remove the humidity and dry the sauna cabin.



Afterheating temperature

This functions allows to set the temperature for the „sauna dry“ program. Factory default setting is 90°C.



Fan running time

Here you can set how long the fan should operate after the humid mode. Factory default setting is 30 minutes. We recommend to use this function in combination with the „sauna dry“ program in order to remove the humidity and dry the sauna cabin.



Hysteresis

Allows to adjust the hysteresis within +/- 10°C range. This adjusts the lower and the upper level for the sensor response to temperature changes, which switches the heater on or off. For instance at 90°C target temperature and hysteresis set to 5°C the control unit will switch the heater on at 85°C and off at 95°C respectively. This allows you to better adjust the sauna heater to the specific sauna cabin size and layout.

Attention! The smaller hysteresis value will lead to considerably increased number of relay switchings, which reduces the service life expectation of the control unit!

The factory default setting is 5K. Make sure to adjust this value with care!



Basic-Setup

Here you can repeat the essential setup steps - selection between the private and commercial sauna use type, configuration of the safety system availability (for EU located saunas) and the selection of the connected heater type (dry sauna heater or Bi-O heater with vaporizer).

Hint: you can disable the vaporizer, the Emotec H model will then function as the Emotec D.



Reset

Allows you to reset the unit back to the factory default settings. All individual settings will be lost. The control unit will restart and will prompt to perform the basic setup steps as by the first switching.



Contact details

Here you can check the stored contact details. By default the contacts of the control unit manufacturer will be shown. If an optional micro-SD card with personalized firmware is inserted, the individual contact details will be shown.



Potential-free contact

Allows to enable or disable the potential-free contact switching function. If enabled the corresponding symbol will be shown in the main navigation menu, so that the end users may switch the connected external equipment. By default this feature is disabled.



Temperature adjustment (offset)

With this function you can offset the displayed temperature to +/- 10°C in relation to the real measured value. For instance by the setting „-10°C“ and real air temperature 90°C the display will show only 80°C.

This allows you for instance to adjust the displayed temperature to match the value shown on the wall thermometer.

Notice: This function may bear potential risks, for this reason it should be set with due care by an experienced specialist and has to be properly tested.



Back (exit service level)

Press on the  symbol in order to exit the service level. Alternatively you can press shortly the „Home“ button on the control panel (on/off button).

The service level will be automatically closed if you do not operate the jog dial knob for 15 seconds.

The control panel will then return to the start screen.

Troubleshooting (error messages)

The Emotec control units may detect a variety of errors and will display an error message on the screen. The errors will be displayed in text form which allows to identify the reason of the fault easier and to rectify it faster. Additionally the control panel will display on alternating basis the contact information, so that the end user could contact the manufacturer or the dealer immediately without having to search for this information in the manual or other records.

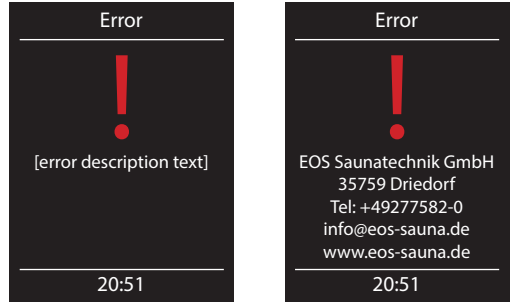

Errors / Error messages

Display remains dark

Sensor fault

Thermofuse released

Water shortage

No Bus communication

Unknown error:

If any other unidentified error messages appear, please contact EOS service. Make sure to supply the serial number, fault details and other relevant information.

Reason / Troubleshooting

- No power supply - check fuses, check cables.
- Switch-Off switch in off position - check the device's main switch for correct position.
- Faulty connection to control panel - check the link cable (relay box - control panel) for reliable connection.
- Control panel in sleep mode - rotate the jog dial.
- Faulty connection to the main sensor - the sensor and cabling for reliable connection.
- Faulty sensor- get the sensor replaced by the dealer.
- Faulty connection - check the white cable (loose wire, faulty contact, etc.)
- Thermofuse blown because of overheating - check the possible reason for overheating, replaced the fuse (one spare fuse is included with every controller).
- Too little water in vaporizer - refill water. Observe the pre-set grace time for refilling, otherwise the vaporizer will be shut-down!
- By automatic refilling - check the water supply line, check the FWA water level control device.
- Check the cable connection between the relay box and the control panel.
- Restart the control unit; if the fault persists, contact the dealer or EOS service.
- Check cable connections and restart the control unit; if the fault persists, contact the dealer or EOS service.

The device „Switch-off“ switch

You will find the rocker switch on the left side of the main relay box. You can completely disconnect the control unit from the mains using this switch.



Attention! Parts of the printed circuit board will still remain energized in the switched off condition! Risk of electric shock!



Device's main switch

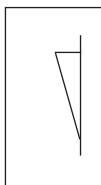

Device switched on
(factory default)

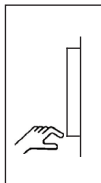

Device switched off
(completely);
Position 0.



Light enabled;
Device switched off.
Position I.

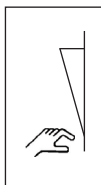

Device switched on.
Position II.

Press the switch on the left side of the rocker to the first latch (**switch setting 0**). The switch will be in the middle position. The unit is now completely switched off (disconnected).

To turn the light on in the cabin while the unit is still disconnected push the left side of the rocker to the second latch (**switch setting I**).

To make the unit ready for operation, switch back to the initial position (**switch setting II**). The unit will return to stand-by mode.

Please keep this address in a safe place together with the installation guide.

To help us answer your questions quickly and competently please provide the information printed on the type shield including the model, item no. and serial no., in all inquiries.

Service Address:

EOS Saunatechnik GmbH
Schneiderstriesch 1

35759 Driedorf, Germany

Tel: +49 (0)2775 82-514

Fax: +49 (0)2775 82-431

servicecenter@eos-sauna.de

www.eos-sauna.de

WARRANTY

The warranty is provided according to the legal regulations at present.

Manufacturer's guarantee:

- The period of guarantee starts from the date of purchase and lasts up to 2 years by commercial use and 3 years by private use.
- Always include the completed guarantee certificate when returning equipment.
- The guarantee is void for appliances which have been modified without manufacturer's explicit agreement.
- Damages caused by incorrect operation or handling through non-authorized persons are not covered under the terms of guarantee.
- In the event of a claim please indicate the serial number as well as the item number and model name with detailed description of the fault.
- This guarantee covers defective parts and labour but not the defects caused by wear and tear.

In case of complaint please return the equipment in its original packaging or other suitable packaging (caution: danger of transport damage) to our service department.

Always include the completed warranty certificate when returning equipment.

Possible shipping costs arising from the transport to and from point of repair cannot be overtaken by us.

Outside of Germany please contact your specialist dealer in case of warranty claims. Direct warranty processing with our service department is in this case not possible.

Equipment commissioning date:

Stamp and signature of the authorized electrician:

Handling procedures for return shipments (RMA) - Details for all returns !

Dear customer

we hope that you will be satisfied with the purchased EOS product. In the rear case if you may have a claim and will need to return a product, please follow the procedures specified below. This will enable to ensure a quick and effective handling of the return shipment.

Please observe for all returns!

- Please add the provided **RMA-voucher completely filled out** together with an **invoice copy** to the return shipment! Do not stick it on the goods or on the packaging. **We do not accept return shipments without these papers.**
- Not prepaid parcels **will be refused** and returned to Sender! Please always ask your dealer or EOS service department about the most economical return shipment way.
- **Please pay attention that** the goods have to be sent back in the **original scope of delivery** and in **original packing**.
- We recommend to use an **additional solid and break-proof covering box** which should be padded out with styrofoam, paper or similar. Transport damages as a result of faulty packing are for the sender's account.

Reason of complaint and proceedings:

1) Transportation damage

- Please check the content of your parcel immediately and advise the forwarding company of a claim (parcel service/freight forwarder)
- Do not use damaged goods!
- Ask the forwarder **for a written acknowledgement of the damages.**
- **Report the claim promptly by phone to your dealer.** He will discuss with you how to act in this case.
- If the transport box has been damaged, please use an additional covering box. Do not forget to add the **acknowledgement of the damage of the forwarding company!**

2) Faulty goods

- The implied warranty period is 2 years. Please contact your dealer in case of **faulty or wrong articles or missing accessories.** He will discuss with you the individual case and try for immediate and customer-friendly solution.
- For **economic returns** within Germany you will get an **RMA-number from the manufacturer.**
- All returns have to be in the **original packing of the goods with corresponding accessories.** Please repack the goods to avoid damages. In case of wrong delivery, please do not use this article .

3) Problems of installation and functioning

- Please **read the manual carefully first of all** and pay attention to the indicated assembly or installing instructions.
- **Your dealer should be the first contact person** because he knows his products best and also knows possible problems.
- **In case of function problems with an article,** please check at first whether there is an obvious material defect. The quality system in our factory reduces malfunctions of new appliances to almost zero.