

PATIO L THERMO SAUNA





















INSTALLATION MANUAL

Instructions

1. It is recommended to install the sauna above ground level to prevent the base frame of the sauna from coming into direct contact with the ground. Install a water-resistant material, such as bitumen strips, between the base frame and the base surface.
2. Make sure that the surface on which you install the sauna is level and stable before and after installing the sauna. Otherwise, the doors of the sauna may not open and close properly later on.
3. During the first heating of the sauna, it must be constantly supervised, and the doors should be kept open, as the stove emits a specific odor when first heated. Read more from the user manual for the sauna stove.
4. The maximum permitted temperature in the steam room is +90 °C. If heated to a higher temperature, the sauna may become overheated.
5. In order to avoid damage caused by the weight of snow in winter, any snow should be removed from the roof of the sauna. Keep in mind that the roof covering should not be damaged during snow removal.
6. If your sauna has lighting, install a 3G 2,5 mm outdoor power cable and connect it in accordance with the schematics on the plug socket coupler provided with the sauna. The power cable of the sauna must be connected to a residual-current circuit breaker! Consult an electrician if necessary.

Required tools

	Tape measure		Cutting knife		Respirator
	Pencil		Battery drill		Scissors
	Level		Nail gun		Tin shears
	Rubber mallet		Circular saw		Pliers
	Hammer		Gloves		Hole saw Ø 100 mm
	Hand saw		Safety goggles		Jigsaw
	Silicone gun				

Floor plan

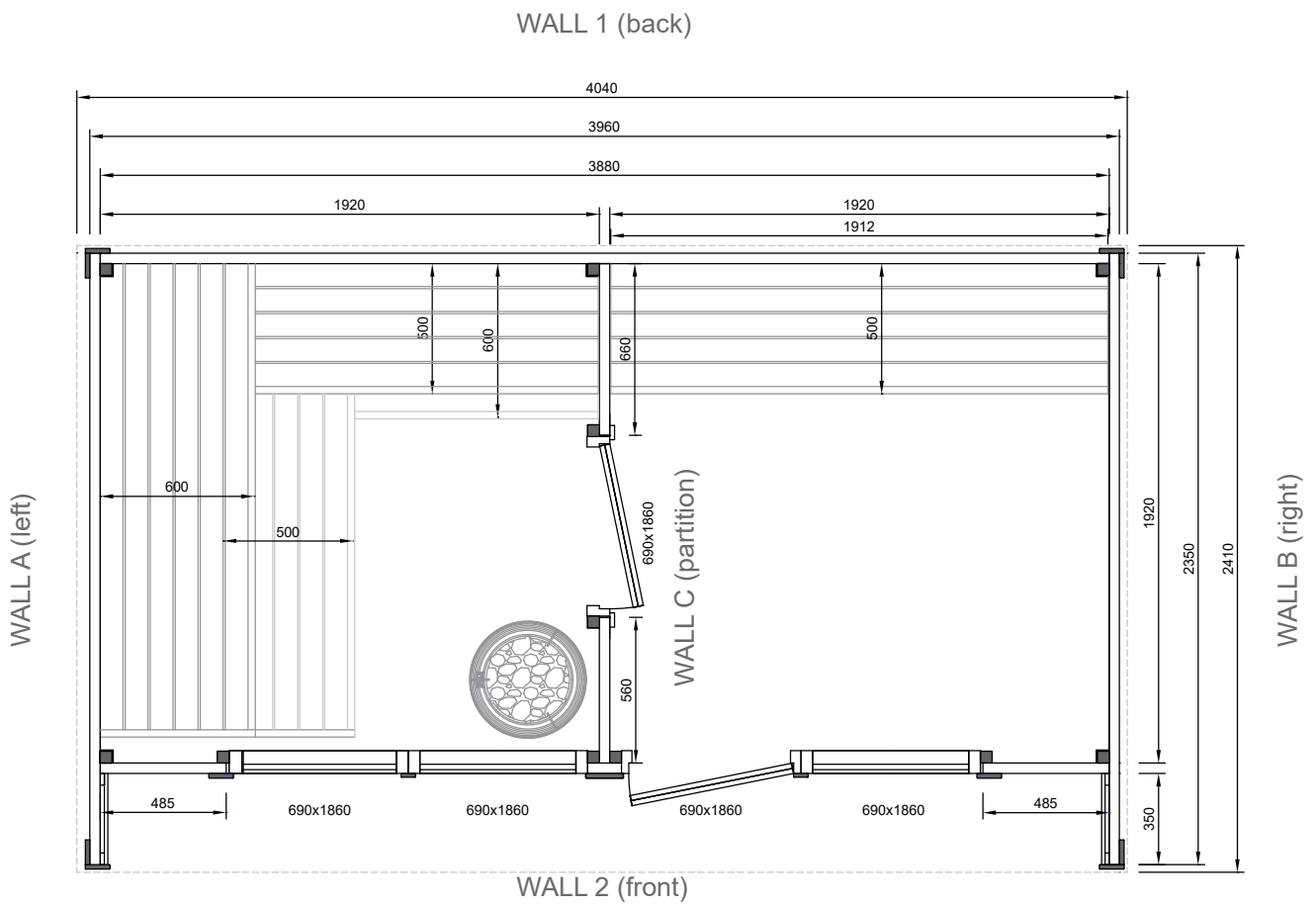

Cross section

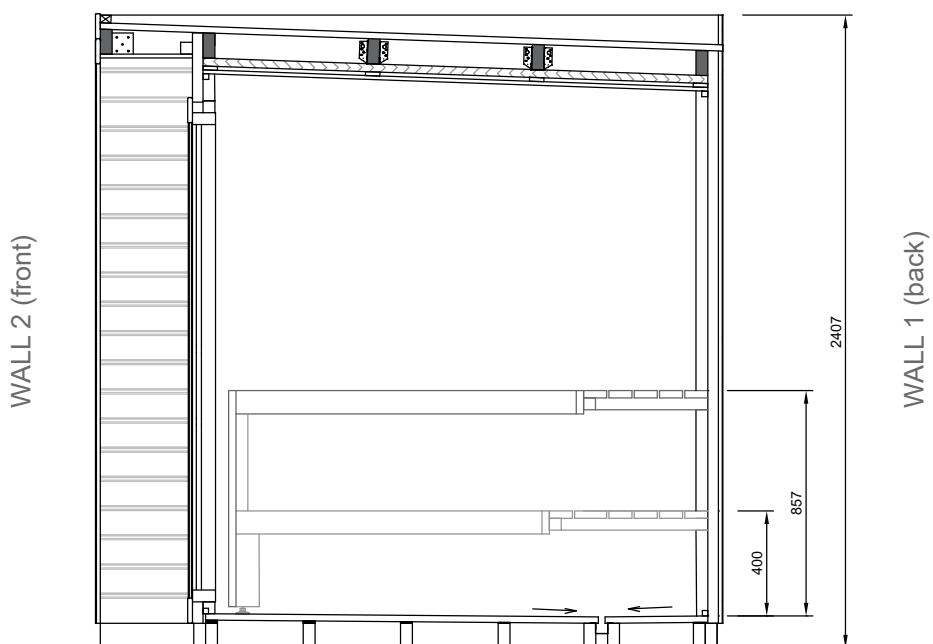

STEP 1 - Base frame

Marking	Detail	Image	Note	Length	Pcs.
AR-1	45x95 Base Frame			3860	4
AR-2	45x95 Base Frame			2345	1
AR-2A	45x95 Base Frame		<i>Cutout!</i>	2345	1

AR-3	45x95 Base Frame			1915	4
AR-4	45x95 Base Frame			1900	5
AR-5	45x95 Base Frame			1810	1
VR-1	Drainage detail			1965	1

Marking	Detail	Image	Note	Length	Pcs.
	Screw 5x90		for base frame		70

1.1 Connect the base frame details according to Scheme 1.1.

Make sure that the frame is level and that the diagonals are equal ($X = Y$). Leave a 45 mm gap between two AR-1 base frame details so that the water drainage detail VR-1 can be fitted between them. Use a level, a battery drill, and 5x90 screws to join the base frame together.

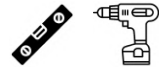

1.2 Place the VR-1 drainage detail on top of the base frame.

No fixings are needed.

Caution! The detail has sharp edges; use gloves.



Check diagonals: $X=Y$

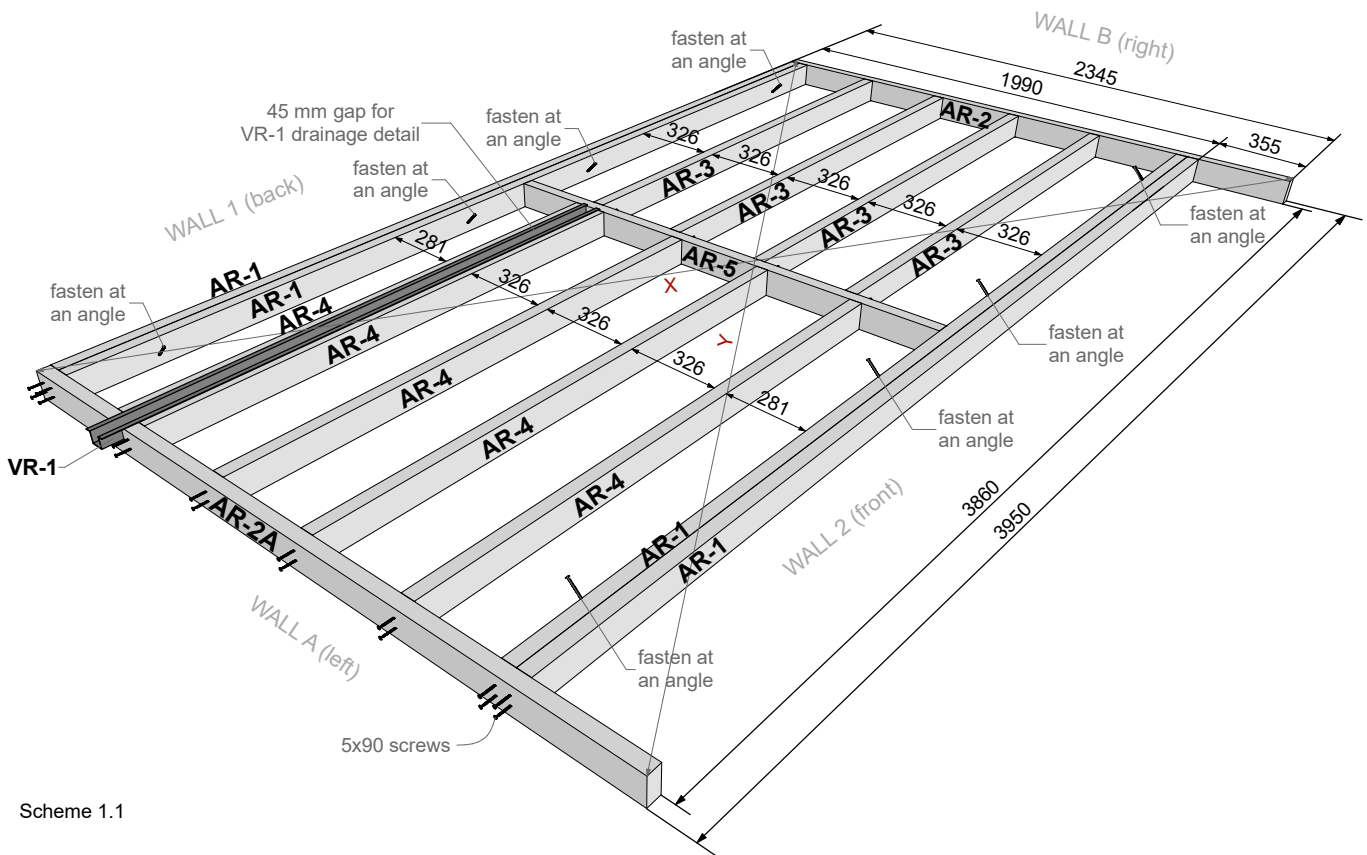

$X= 4594$ mm

$Y= 4594$ mm





Scheme 1.1

STEP 2 - Walls

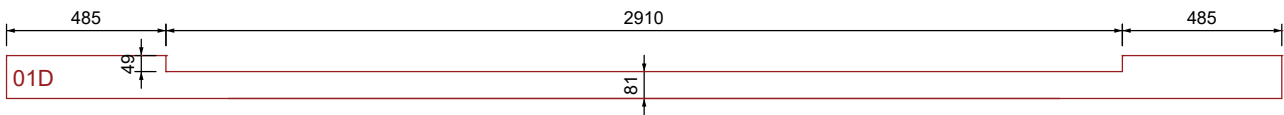
Marking	Detail	Image	Note	Length	Pcs.
01	40x138 Wall Log Thermo			3880	18
EXTRA	40x138 Wall Log Thermo			3880	2
01B	40x96 Wall Log Thermo		<i>Height: 96 mm</i>	3880	1
01C	40x34 Wall Log Thermo		<i>Height: 34 mm</i>	3880	1
01D	40x138 Wall Log Thermo		<i>Cutout!</i>	3880	1



02	40x138 Wall Log Thermo			2350	34
02B	40x102 Wall Log Thermo		<i>Height: 102 mm</i>	2350	2
03	40x138 Wall Log Thermo			1920	1
03B	40x96 Wall Log Thermo		<i>Height: 96 mm, Cutout!</i>	1920	1

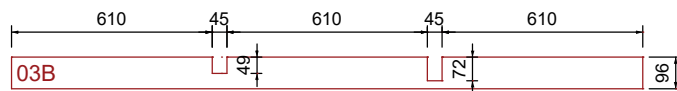

03D	40x138 Wall Log Thermo		<i>Cutout!</i>	1920	1
-----	------------------------	--	----------------	------	---

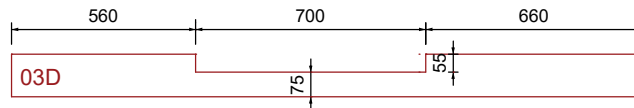

05	40x138 Wall Log Thermo			660	14
06	40x138 Wall Log Thermo			560	14
07	40x138 Wall Log Thermo			485	28
EXTRA	40x138 Wall Log Thermo			485	4
	Hitting Block				2

P-1	45x45 Corner Post			2190	3
P-2	45x45 Corner Post			2120	3
AT-1	45x45 Temporary Support		for corner post installation	~1800	12

Marking	Detail	Image	Note	Length	Pcs.
	Screw 6x180		for every wall log		350
	Screw 4.5x70		for P-1 and P-2 corner posts		400
	Screw 4.5x70		for AT-1 temporary supports		25

STEP 2 - Walls

- 2.1 Place the first row of wall logs on the base frame according to Scheme 2.1. Make sure that the wall logs protrude 5 mm outward from the base frame on all sides. Use 6x180 screws to fix the wall logs to the base frame.

Suggestion: Pre-drill the holes for the screws to prevent wall logs from splitting.

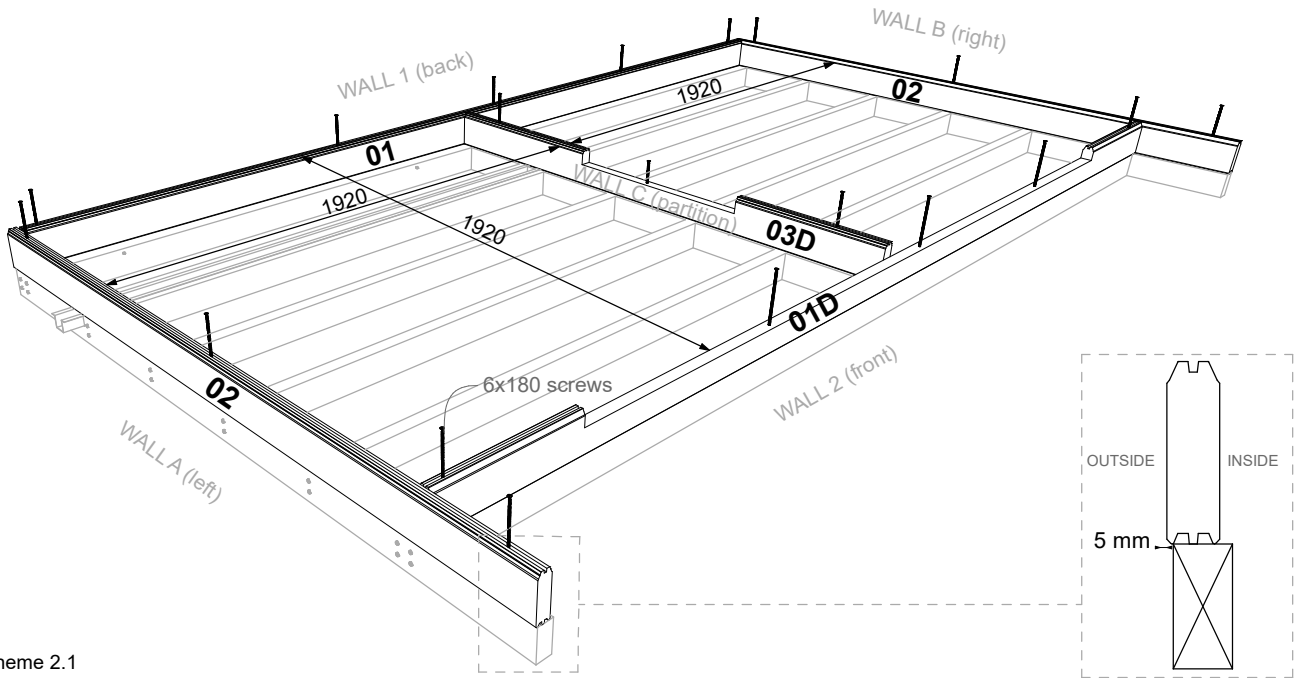
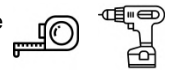

Scheme 2.1

- 2.2 Place the second row of wall logs on top of the first row. Use a hitting block and a rubber mallet to set the logs in place. Attach the second row to the first using 6x180 screws and a battery drill.

Suggestion: Pre-drill the holes for the screws to prevent wall logs from splitting.

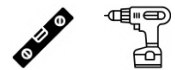

- 2.3 Install corner posts in the inner corners. Leave a 45 mm gap at the bottom, between the corner posts and the base frame. Use 4.5x70 screws and a drill to fix the corner posts to every wall log (Scheme 2.2).

Suggestion: Pre-drill holes for the screws to prevent the posts from splitting.



- 2.4 Vertically level the corner posts and temporarily attach AT-1 details to them for support and to keep the posts in a level position. Use a level, 4.5x70 screws, and a battery drill.

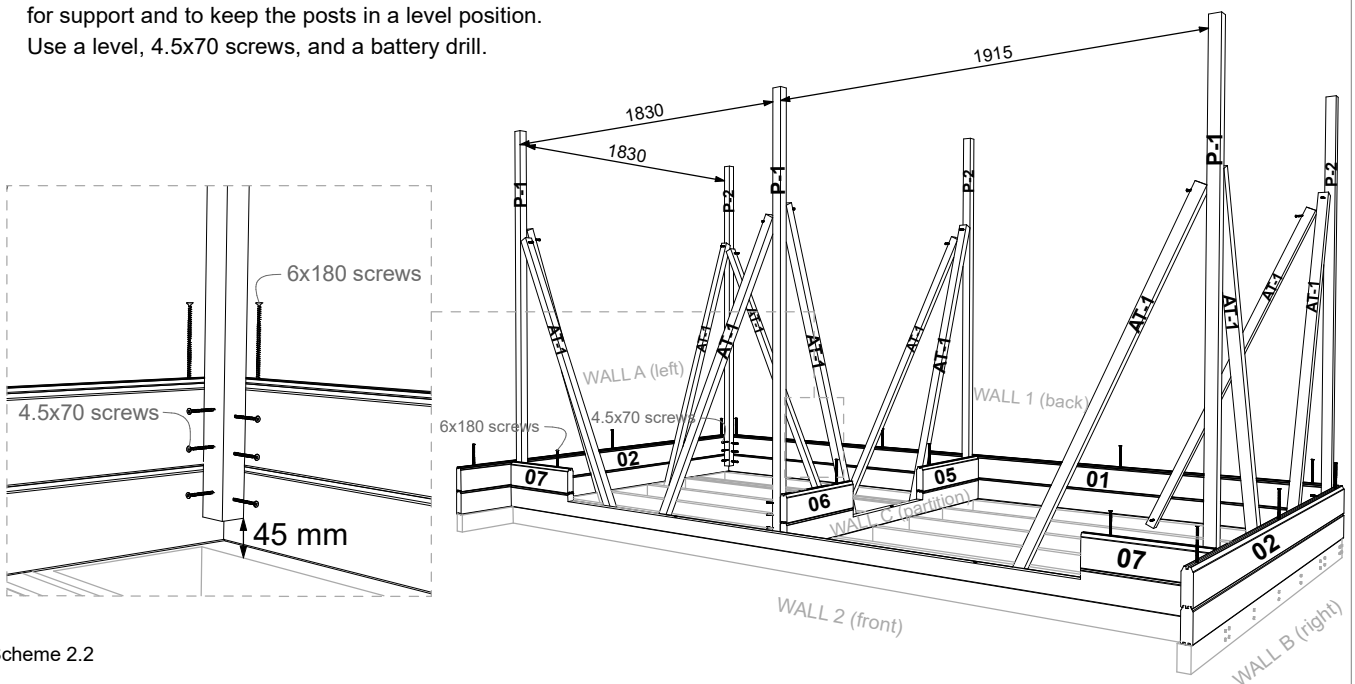

Scheme 2.2

STEP 2 - Walls

2.5 Continue to install the wall logs on top of each other according to the "Wall Layout" scheme on page 7. Use 6x180 screws to connect all wall logs to each other and 4.5x70 screws to fix all logs to corner posts, like shown in Scheme 2.3.



2.6 Remove the AT-1 temporary support details after all wall logs have been installed.

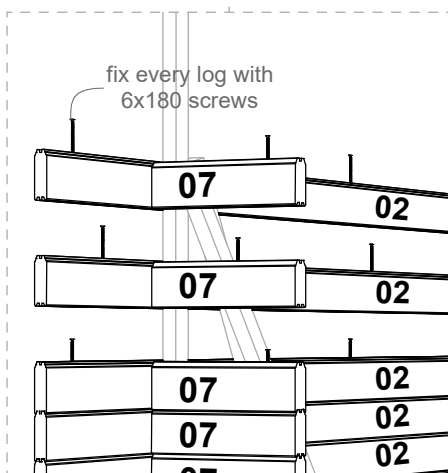
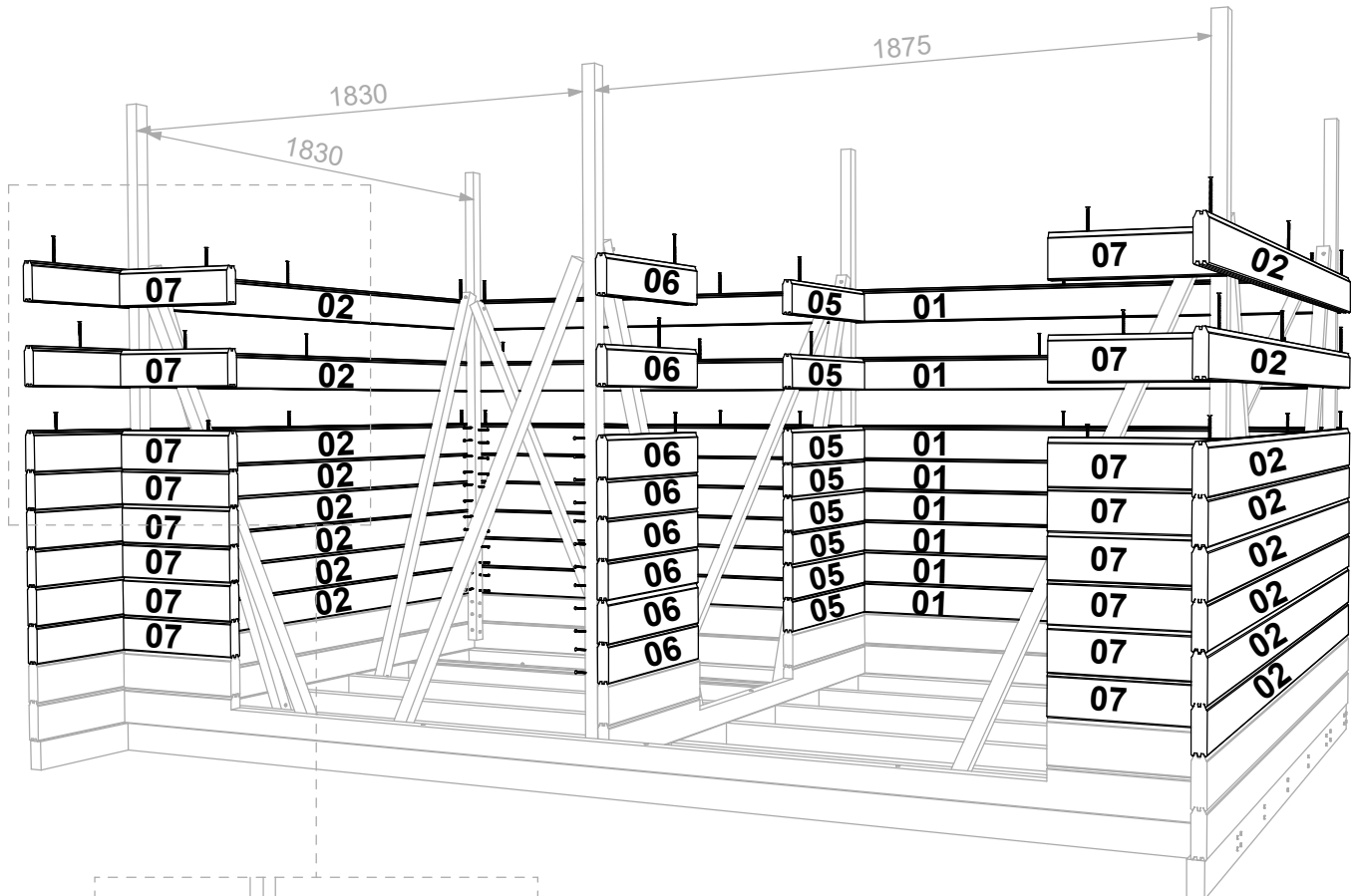

Scheme 2.3

For installation of walls, see the placement of the wall logs on the "Wall Layout" scheme on page 7.

WALL LAYOUT

- * Connect all wall logs together using 6x180 screws.
- * Connect all wall logs to corner posts using 4.5x70 screws

Wall 2 (front)

View from the outside

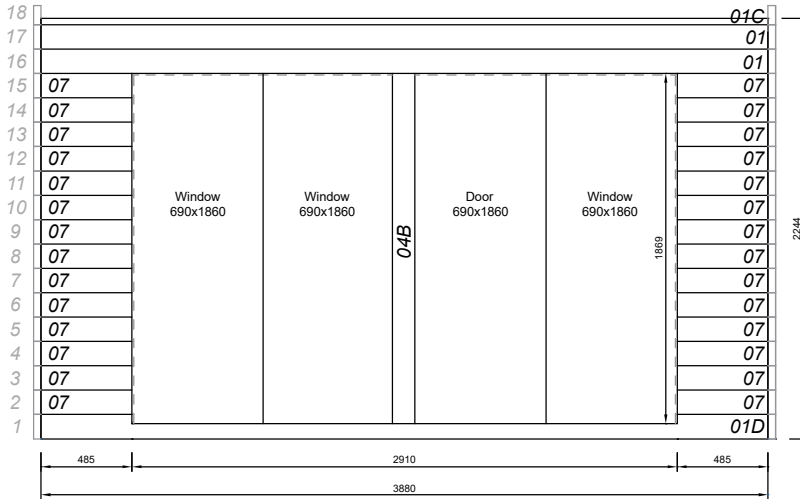

Wall A (left)

View from the outside

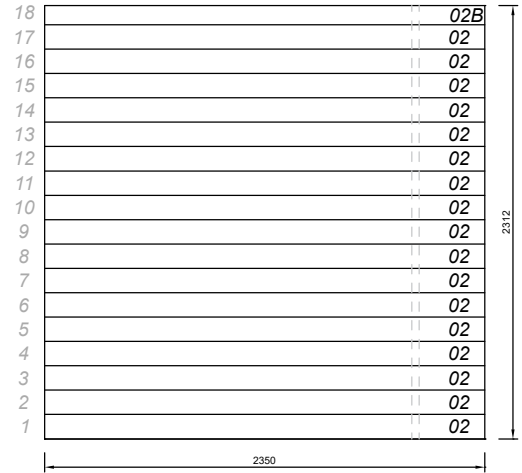

Wall 1 (back)

View from the outside

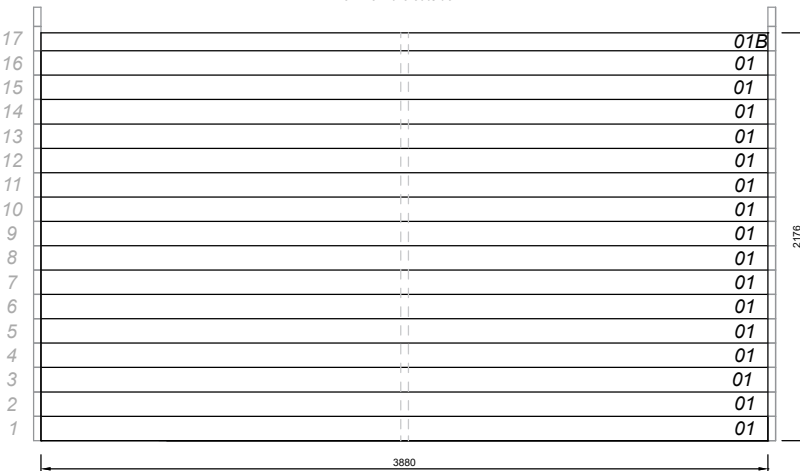

Wall B (right)

View from the outside

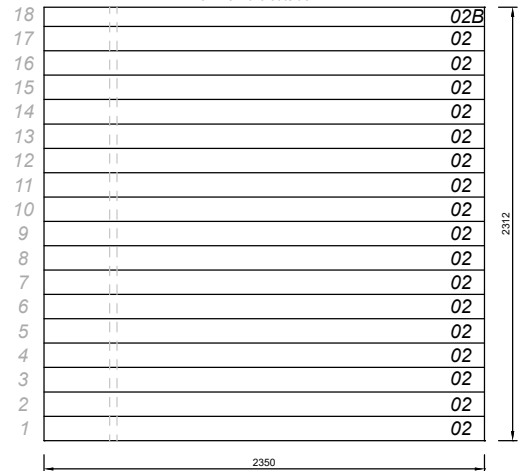



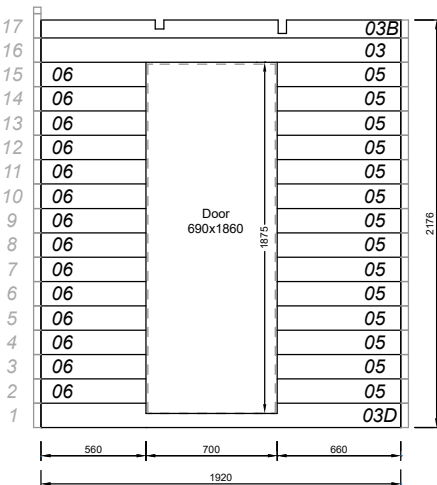

Wall C (partition)

View from the anteroom



STEP 3 - Roof boards and ceiling

Marking	Detail	Image	Note	Length	Pcs.
KL-1	24x120 Roof Board			2370	36+2
O1F	40x30 Roof Block			3880	1
T-1	45x95 Ceiling Beam			3878	2
T-2	45x95 Ceiling Beam			3878	2
T-3	45x95 Ceiling Beam			1870	2
T-4	45x95 Ceiling Beam			1825	2
T-5	45x45 Ceiling Beam			3880	1
DI-2	15x55 Ceiling Distance Board			1915	4
DI-3	15x55 Ceiling Distance Board			1870	1
DI-4	15x55 Ceiling Distance Board			1825	3
	SPU Insulation Panel 30x600x1200				11
STP-1	15x90 Ceiling Board		<i>Thermo spruce</i>	1915	48+2

Marking	Detail	Image	Note	Length	Pcs.
	Joist Hanger 45x97		for fixing T-2 beams		4
	Plastic wedge 90x32x15		for supporting T-2 beams if necessary		4
	Corner Bracket 60x60x60		for T-1 beam		2
	Screw 5x40		for joist hangers		50
	Screw 4.5x70		for beams and distance boards		100
	Nail 70 mm		for KL-1 roof boards		300
	Lost-head nail 40 mm		for STP-1 ceiling boards		200
	Foil Tape		for SPU insulation panels	10 m	3

3.1 Attach the T-3 and T-4 beams to the front and back walls. Leave ~2 mm gap at both ends. Make sure that the top side of the beam is flush with the upper edge of the front and back walls. Use 4.5x70 screws and a drill to fix the beams to the walls (Scheme 3.1).

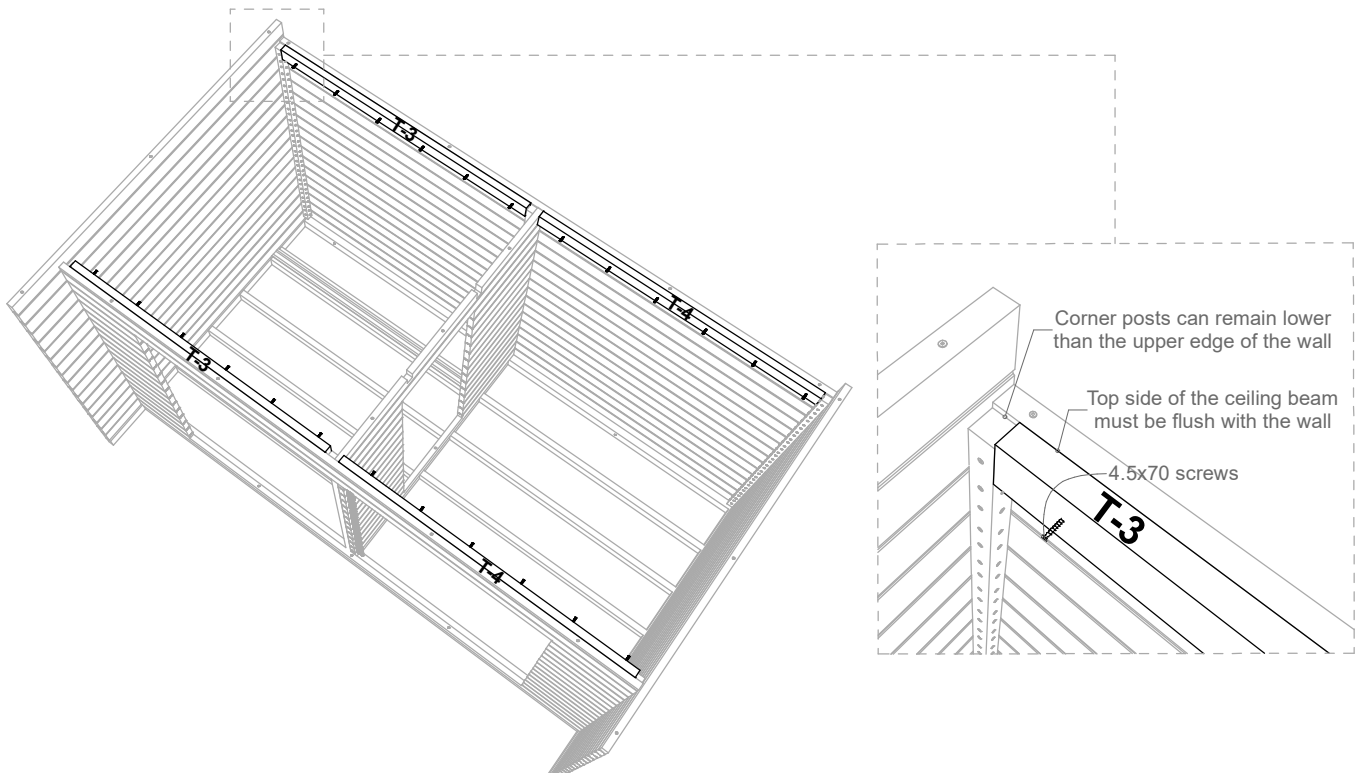

Scheme 3.1

STEP 3 - Roof boards and ceiling

- 3.2 Temporarily lay one KL-1 roof board or some other straight detail on top of the front and back walls. Mark the diagonal that forms under the detail on the side walls with a pencil. These markings will determine the installation height of the T-2 ceiling beams. Measure out the distance from the T-3 and the T-4 beams and mark the locations on both side walls, like shown in Scheme 3.2. These markings will indicate the spacing between the T-2 ceiling beams.

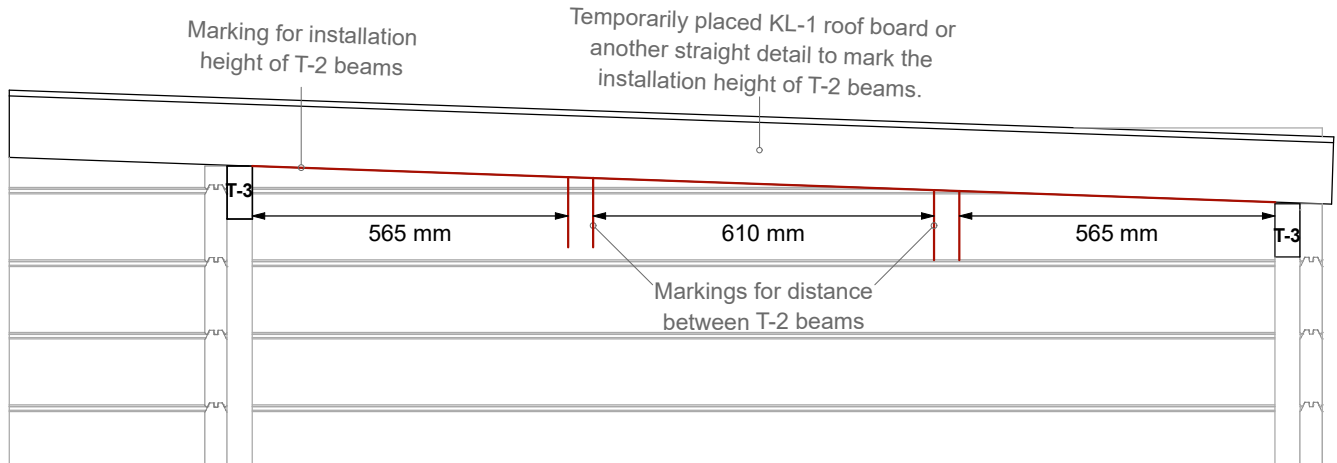

Scheme 3.2

- 3.3 Attach the joist hangers to the T-2 ceiling beams, flush with the beams ends. Use 5x40 screws.



- 3.4 Install the T-2 ceiling beams through the cutouts in Wall C (partition). Fasten them to the side walls in the previously marked location through the joist hangers, like shown in Scheme 3.3.

Use 5x40 screws to fix the joist hangers to the beams and the walls.

The T-2 beams should support the roof boards in the middle of the sauna. If necessary, raise the beams higher from the cutouts in Wall C (partition) and position them to the correct height using plastic wedges.

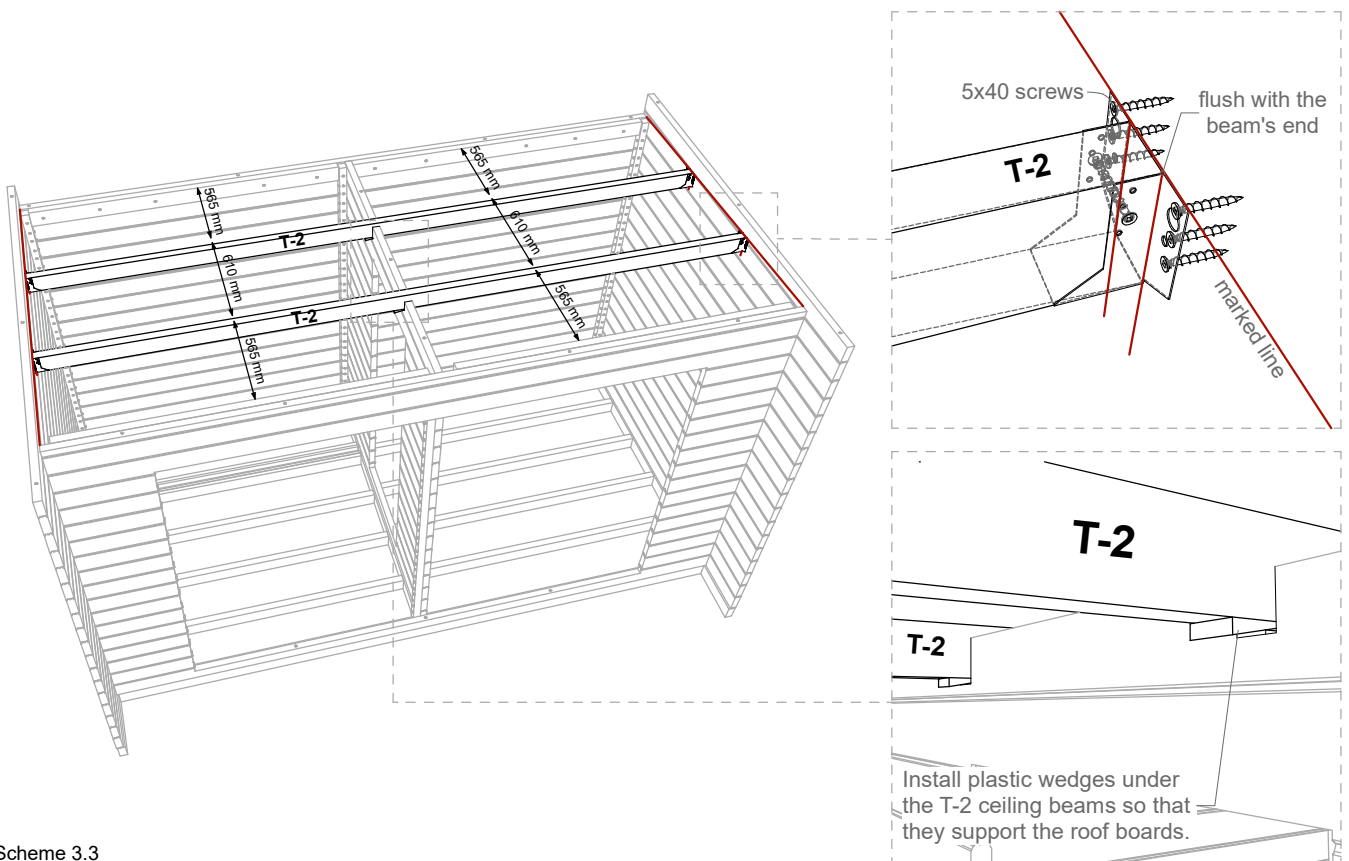

Scheme 3.3

STEP 3 - Roof boards and ceiling

- 3.5 Install the roof boards flush with the side walls, starting from the right. Fix the roof boards with 70 mm nails to the beams (8 nails per every roof board) with a hammer or a nailgun. Cut the last roof board to width using a circular saw.

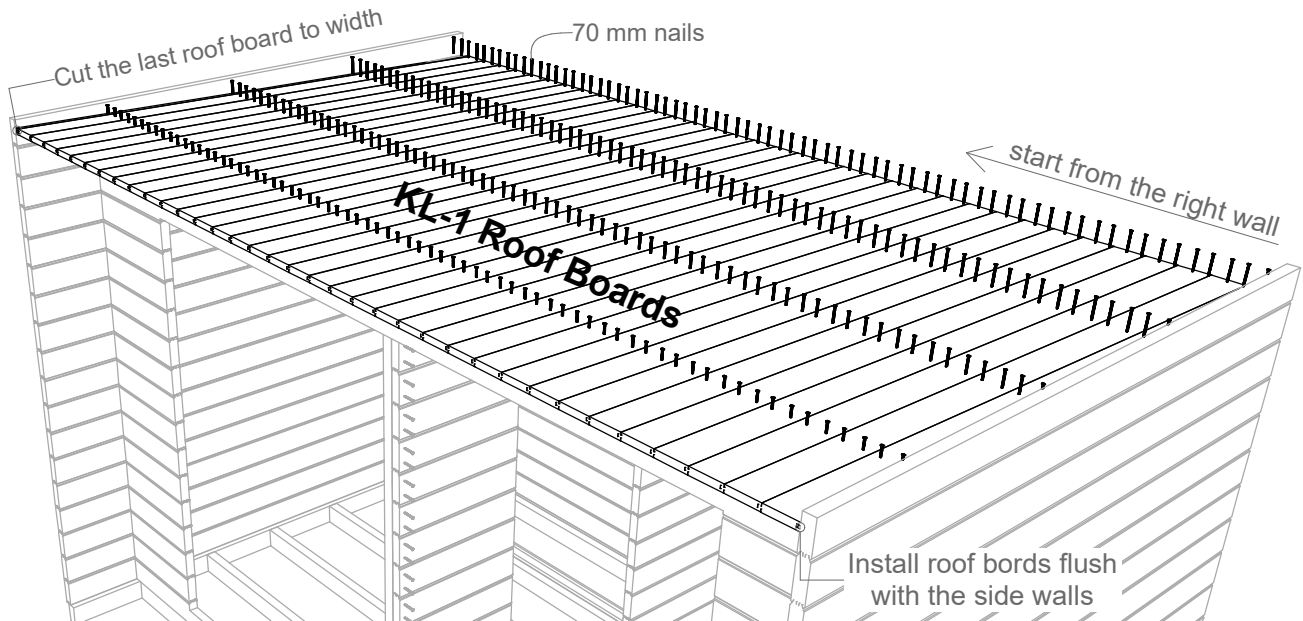

Scheme 3.4

- 3.6 When all the roof boards are installed, fasten the T-1 beam under them, flush with the roof boards at the front, like shown in Scheme 3.5. Use 60x60x60 angle brackets and 5x40 screws for fixing.



- 3.7 Measure the distance from the roof boards to the bottom edge of the T-1 beam and mark it on Wall 2 (front). That line will indicate the installation height of the T-5 beam. Fix it in place with 4.5x70 screws.

- 3.8 Install the 01F roof block on top of the roof boards, flush with the front edge. Fix with 4.5x70 screws.

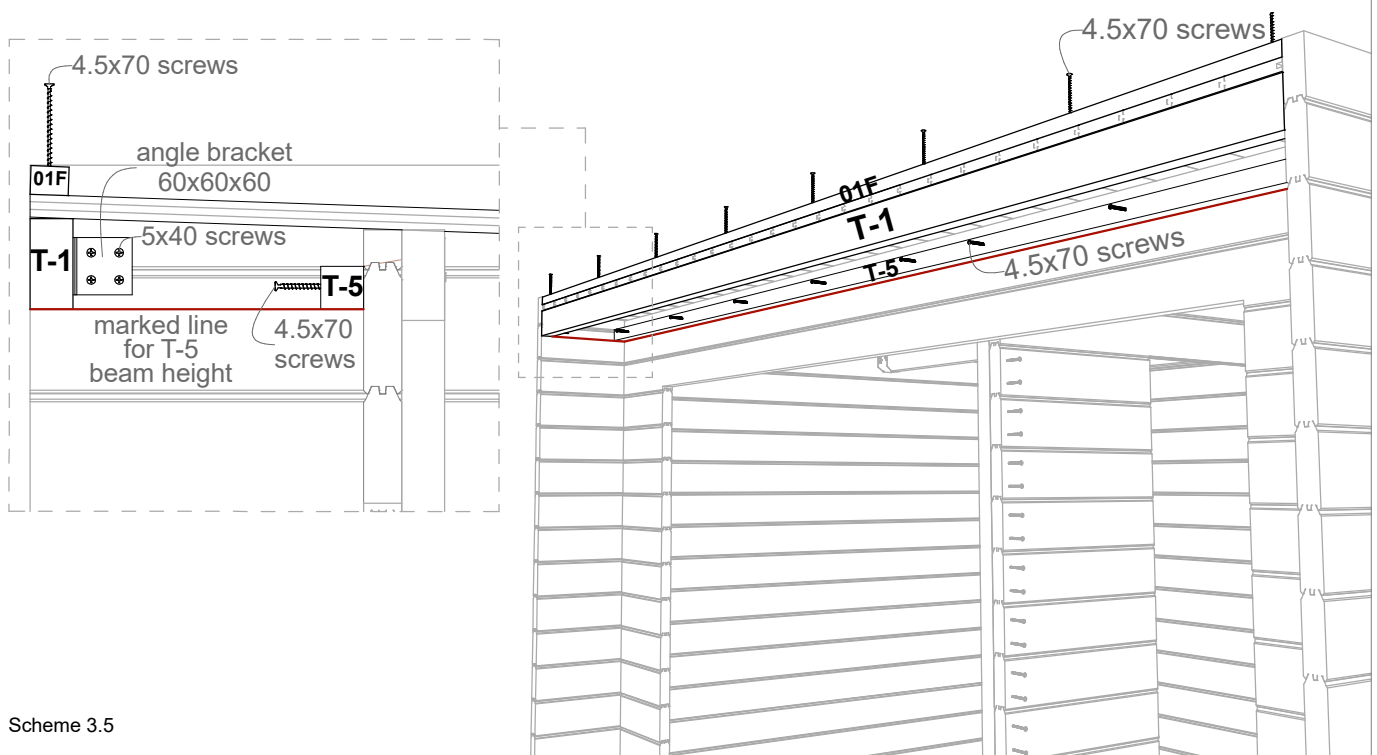

Scheme 3.5

STEP 3 - Roof boards and ceiling

3.9 Cut the SPU insulation panels to the right size using a cutting knife. Make cutouts in the corners for corner posts. Attach the panels to the ceiling beams using a few 4.5x70 screws. Tape all edges and joints with foil tape to prevent heat loss, like shown in Scheme 3.6.

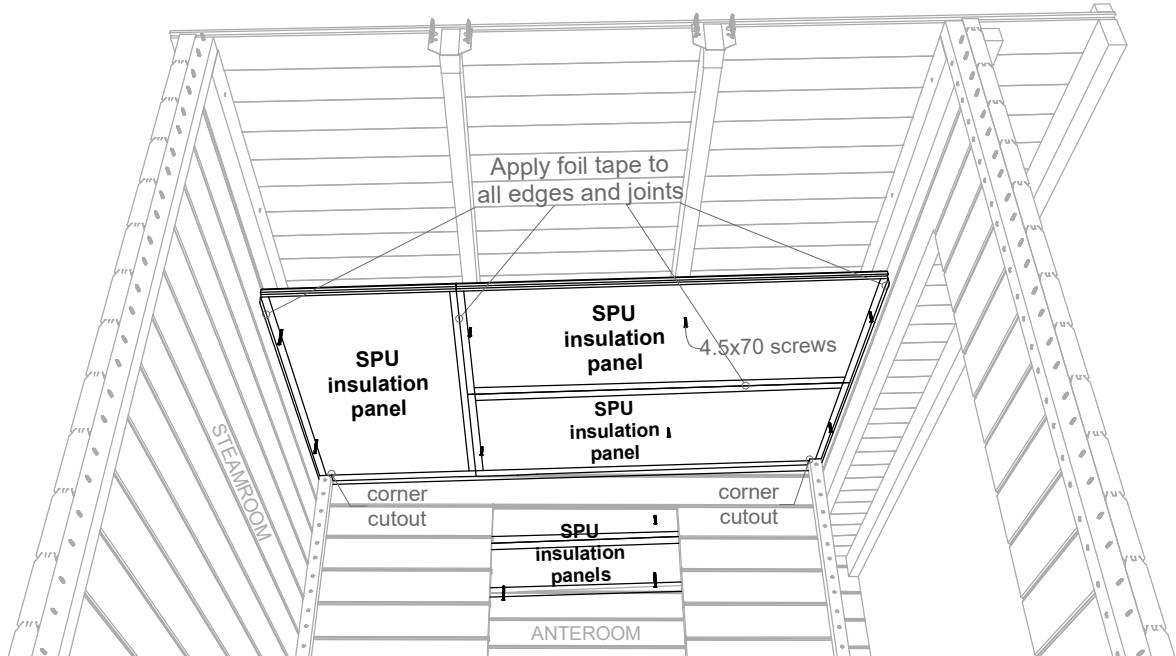

Scheme 3.6

3.10 Place the ceiling distance boards on top of the insulation panels and fasten them to the ceiling beams using 4.5x70 screws.

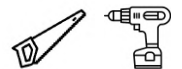

3.11 Install the ceiling lining boards on top of the distance boards. Leave ~3 mm gap between the ceiling boards and walls on all sides. Use 40 mm lost-head nails (4 per every ceiling board) and a hammer or nail gun for fixing. Make corner cutouts in the first and last ceiling boards for corner posts with a hand saw, and cut the last ceiling board to width using a circular saw (Scheme 3.7).

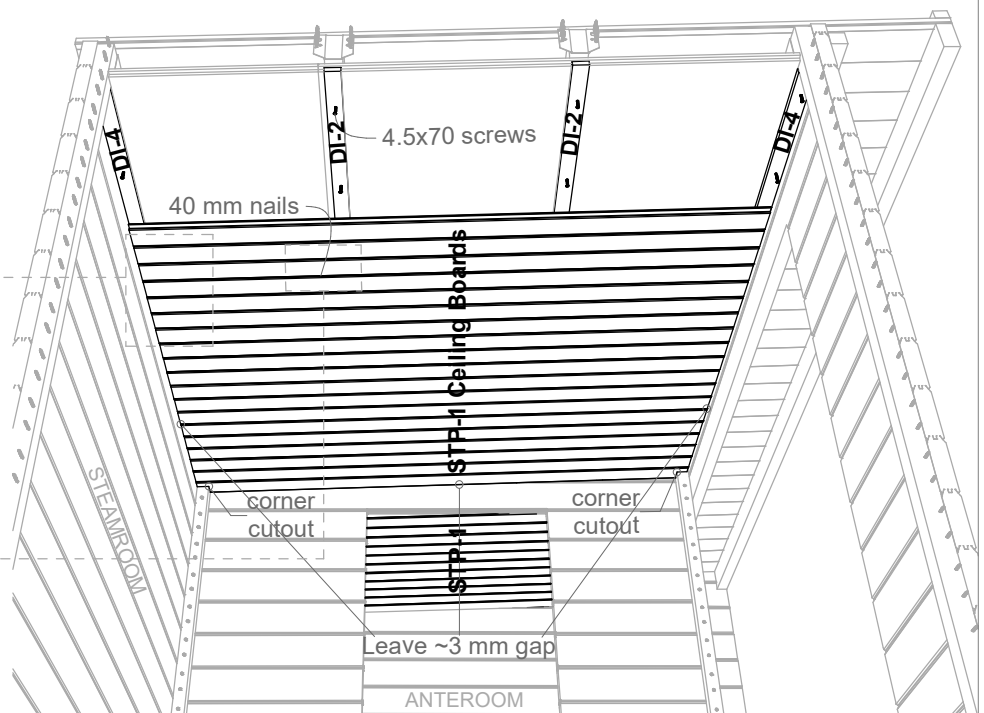
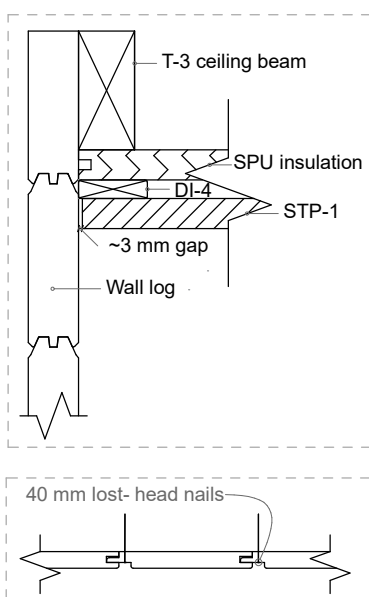

Scheme 3.7

STEP 4 - Floor

Marking	Detail	Image	Note	Length	Pcs.
	3 mm Floor slope veneer			1905	2
	6 mm Floor slope veneer			1905	1
	9 mm Floor slope veneer			1905	1
	12 mm Floor slope veneer			1905	1
PL-1	24x120 Floor Board			1910	18+2
PL-2	24x120 Floor Board			1495	18+2
PL-3	24x120 Floor Board			385	18+2

Marking	Detail	Image	Note	Length	Pcs.
	Screw 3.5x50		for floor boards		250

4.1 Place the slope veneers on the base frame in the steam room to give the floor a slope for water drainage. Fixing the details to the base frame with screws is optional (Scheme 4.1).

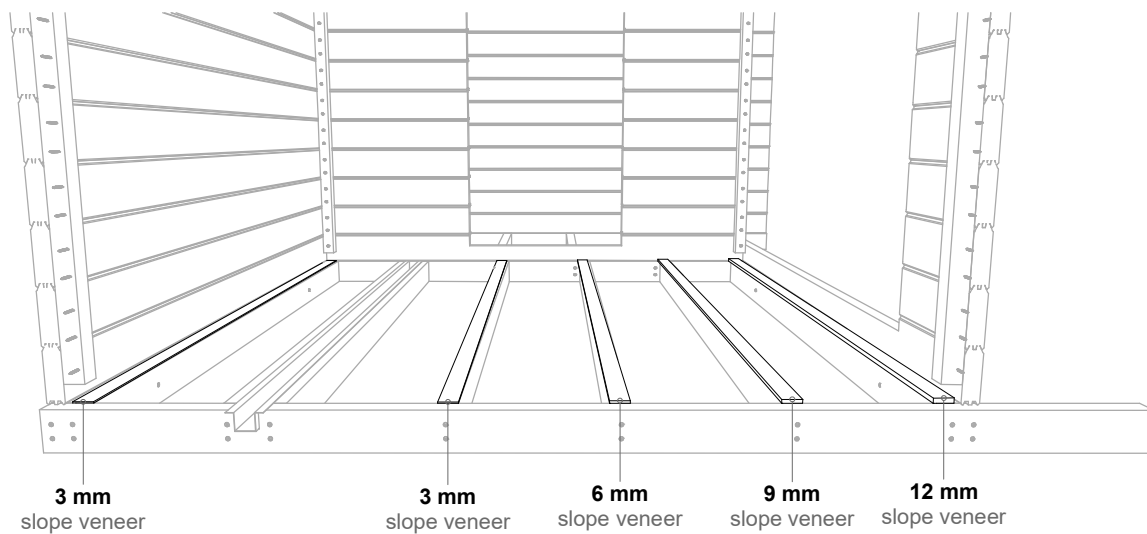

Scheme 4.1

4.2 Install the floor boards starting from the right. Leave ~3 mm gap between the floor boards and walls at all sides. Cut the last floor board to width using a circular saw. Use 3.5x50 screws to fix the floor boards in place (Scheme 4.2).

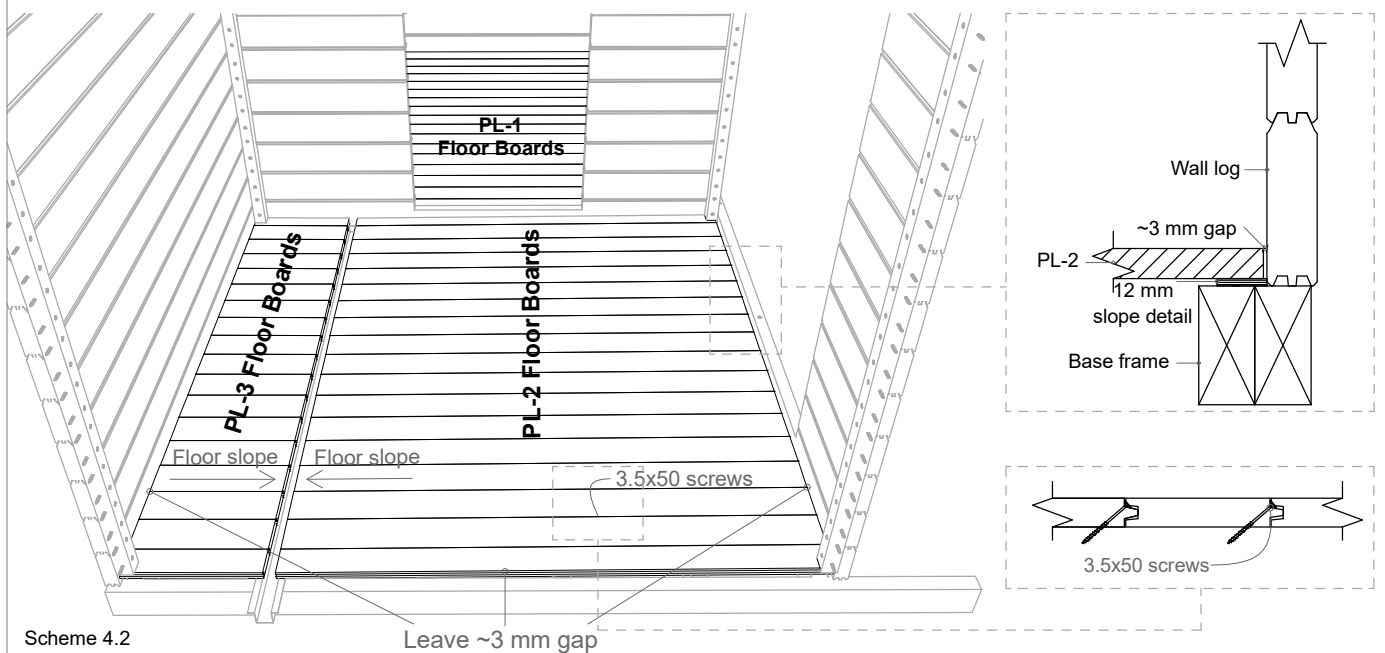

Scheme 4.2

Leave ~3 mm gap

STEP 5 - Doors and windows

Marking	Detail	Image	Note	Length	Pcs.
U-1	Glass Door 88x690x1860		Metal + Metal door handle		1
A-1	Window 88x690x1860				3
U-2	Glass Door 88x690x1860		Metal + Wooden door handle		1
UR-1	45x45 Door/ Window frame			1950	3
UR-2	45x45 Door/ Window Frame			1380	4
04B	40x120 Partition Wall End Board		Width: 120 mm	1869	1

Marking	Detail	Image	Note	Length	Pcs.
	Screw 4.5x70		for door and window frames		100

5.1 Connect the door and windows together by attaching the UR-1 and UR-2 frame details around them. Attach the UR-1 and UR-2 frames with 4.5x70 screws (Scheme 5.2). The U-2 interior door frame is pre-installed at the factory. **Attention!** When installing the window, make sure that the inclined frame is located indoors, at the bottom of the window. The bottom side is marked with a sticker.

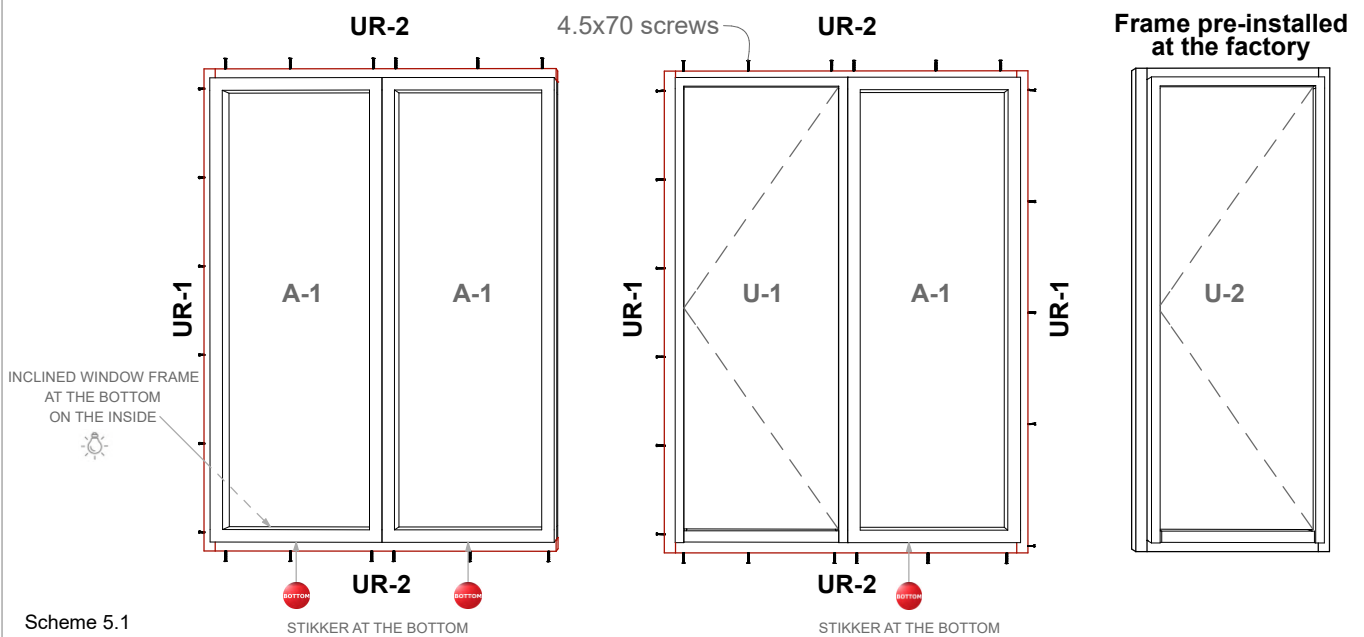

Scheme 5.1

5.2 Lift and tilt the doors and windows diagonally into the openings (Scheme 5.2). Place them to their positions from inside the sauna. For easier installation, remove the glass from the door hinges to reduce the weight of the doors.

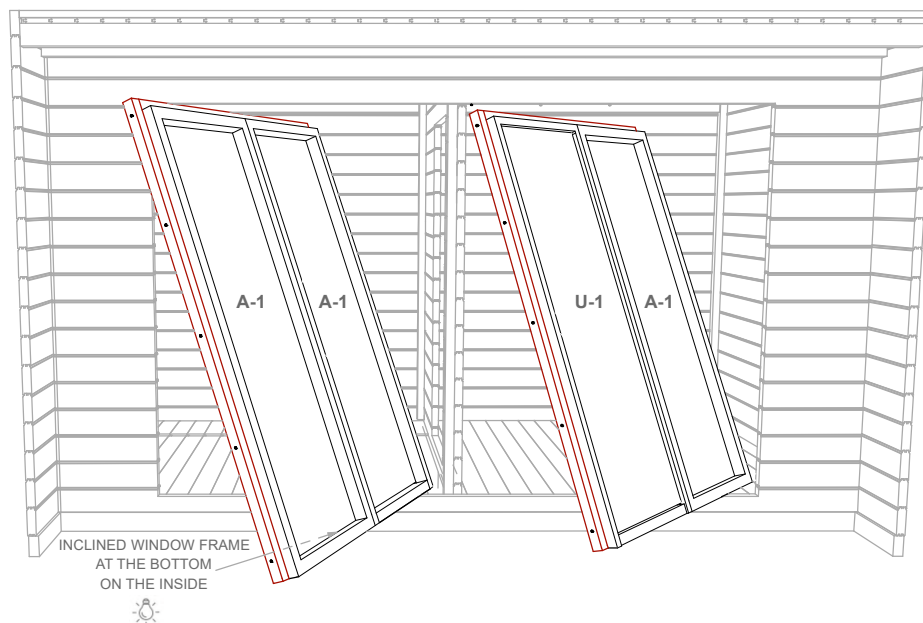

Scheme 5.2

STEP 5 - Doors and windows

5.4 Fix the door and window frames to Wall 2 (front) from the outside. Place and fix the 04B detail between the windows and the door. Use 4.5x70 screws for fixing (Scheme 5.3).



5.5 Attach the glass doors back to the hinges and fix the handles to the doors. The set includes two different handles that look the same but are made of different materials. Make sure that the outer door has a metal and metal handle and the inner door has a metal and wooden handle. A wooden handle must be installed on the inner door facing the steam room so that it does not heat up while using the sauna. The difference in material can be detected by sound (tap on the handles).

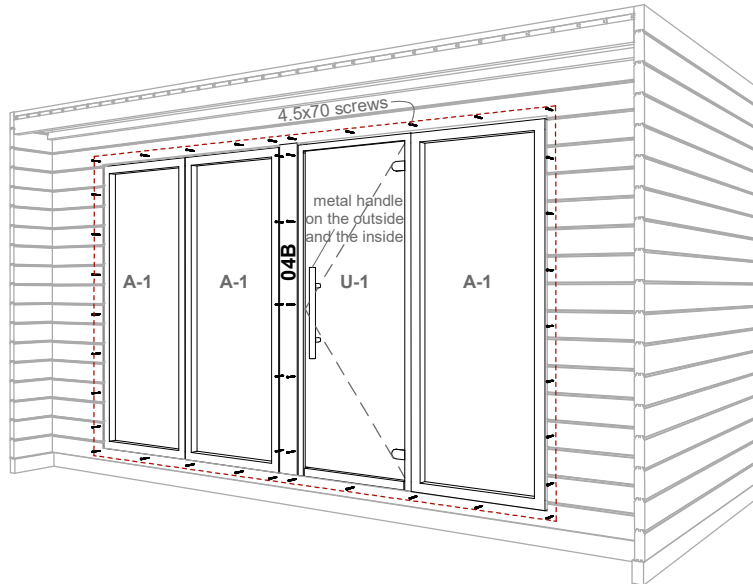

Scheme 5.3

STEP 6 - Ventilation

Marking	Detail	Image	Note	Length	Pcs.
U-2	Ventilation Valve Ø100		wood		1
U-3	Ventilation Grid Ø100		metal		7
	Screw 3x40 Black				25

6.1 Cut the ventilation holes in the partition wall with a diameter of 100 mm using a hole saw or a jigsaw. For recommended locations of ventilation openings see Scheme 6.1

Wall C (partition)

View from the anteroom

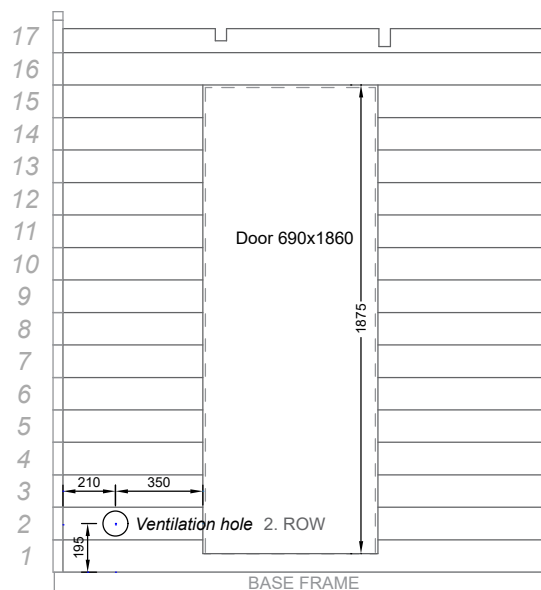

Scheme 6.1

STEP 7 - Ventilation

6.2 Cut the ventilation holes in the exterior walls with a diameter of 100 mm using a hole saw or a jigsaw. For recommended locations of ventilation openings see Scheme 6.2

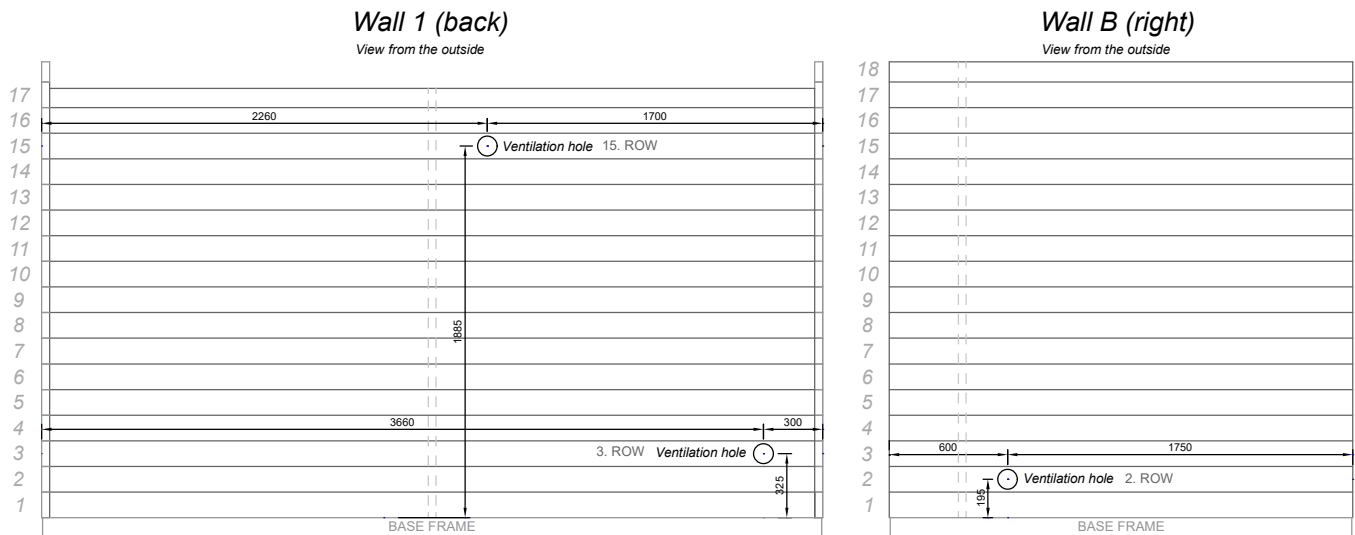

Scheme 6.2

6.3 Cover the openings with ventilation grids or valves, as shown in Scheme 6.3. Use 3.5x40 black screws for fixing.

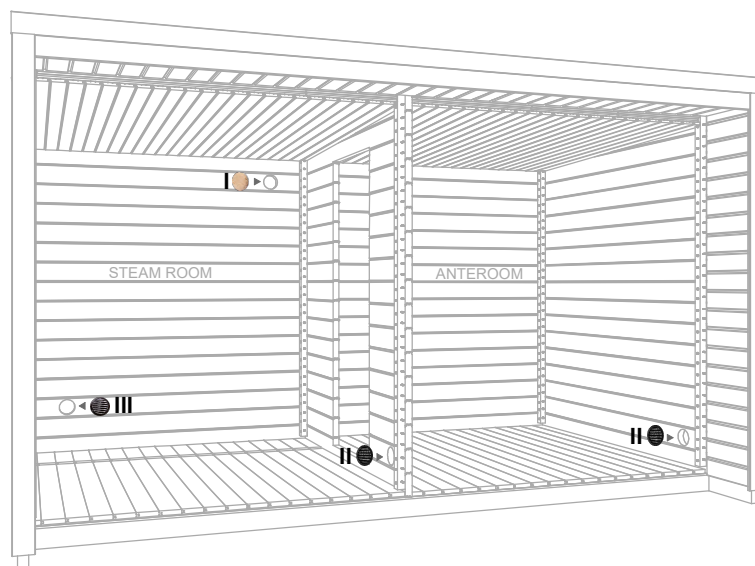

Scheme 6.3

I - EXHAUST OPENING

Install the metal ventilation grid on the outside and the wooden valve on the inside.

The exhaust opening with the valve inside is located under the ceiling, and its purpose is to dry the steam room after using the sauna. The ventilation valve should be closed while using the sauna. Open the valve after using the sauna to expel excess moisture through the opening. For faster drying, leave the steam room door ajar after a sauna session.

The ventilation valve can also be opened between steam sessions if there are many people in the steam room at the same time and excessive humidity or a lack of air occurs.

II - INLET

Install a metal ventilation grid inside and outside.

III - OUTLET

Install a metal ventilation grid inside and outside.

STEP 7 - Outer lining and moldings

Marking	Detail	Image	Note	Length	Pcs.
DI-1	15x55 Distance Board for Outer Lining			2150	4
STP-2	14x121 Outer Lining Board			350	75+3
L-1	18x95 Roof Molding		<i>Cut to length!</i>	~4000	2
EXTRA	18x95 Roof Molding			~4000	1
L-2	18x95 Roof and Corner Molding		<i>Cut to length!</i>	~2400	10
UL-1	18x95 Door Molding			3110	1
UL-2	18x95 Door Molding			2870	1
UL-3	18x95 Door Molding			1925	2
UL-4	18x170 Door Molding			1830	1
UL-5	12x42 Door Molding		<i>Cut to length!</i>	~2200	2

Marking	Detail	Image	Note	Length	Pcs.
	Transparent silicone		for all outside corners		1
	Moisture safety tape		for all outside corners	10 m	1
	Screw 3x40 Black		for distance boards and moldings		200
	Lost- head nail 40 mm		for outer lining boards		150
	Teknos Aqua Primer - Black				1

7.1 Seal the outside corners of the sauna with transparent silicone, as shown in Scheme 7.1. to prevent moisture and rainwater from entering the sauna.

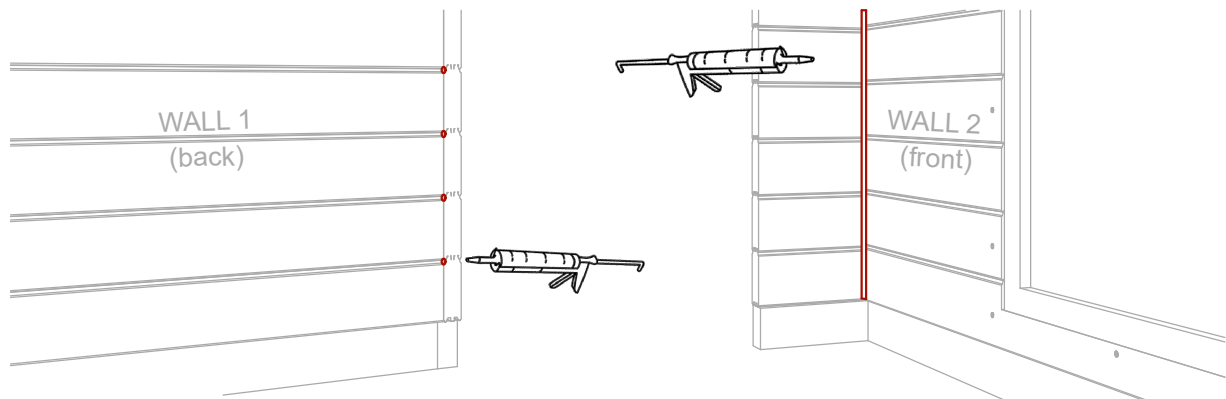

Scheme 7.1

7.2 For extra protection, tape all outside corners of the sauna with moisture safety tape before installing the exterior moldings (Scheme 7.2).

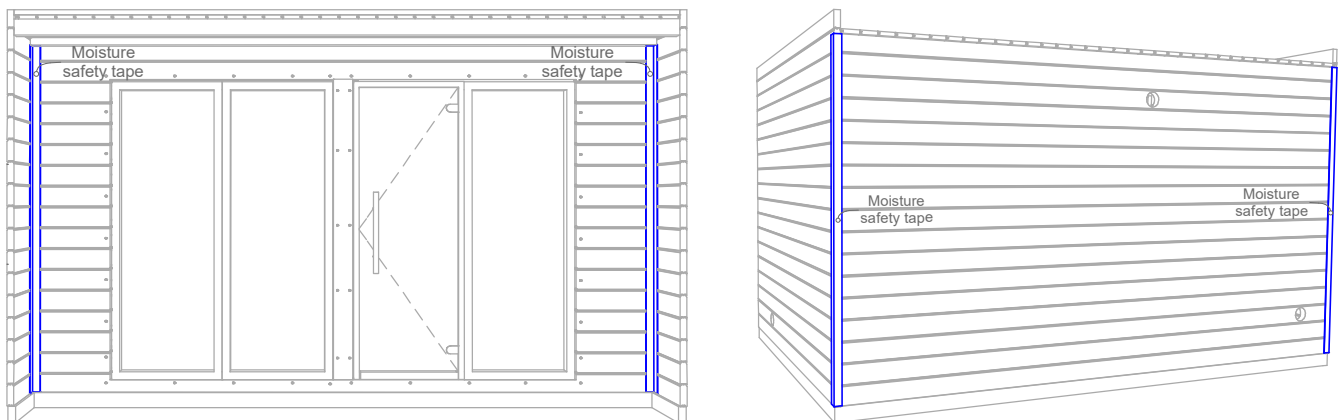

Scheme 7.2

STEP 7 - Outer lining and moldings

7.3 Measure the height of the protruding part of the side walls and cut the DI-1 distance boards to the correct length if necessary. Attach the distance boards to the walls using 3x40 screws.

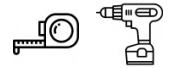

7.4 Install the STP-2 outer lining boards on top of the DI-1 distance boards and the beams, starting from the bottom. Cut the last lining board to the correct width. Use 40 mm lost-head nails to fasten the lining boards (2 nails per board). See Scheme 7.3.

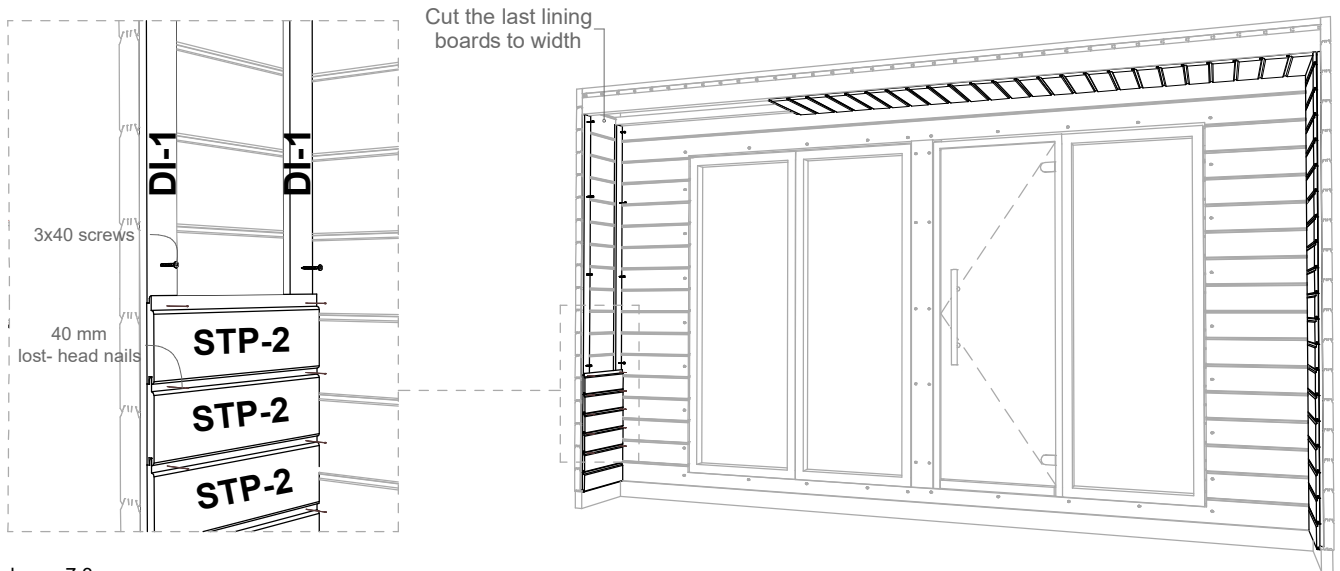

Scheme 7.3

7.5 First, fix the L-2 roof moldings to the side walls. The moldings must be installed flush with the upper edges of the side walls. Cut the moldings to length and fasten using 3x40 black screws.



7.6 Next, measure and cut to length the L-1 roof moldings at the front and fasten them to the roof block and T-1 beam.



7.7 Make corner cutouts in L-2 corner moldings, as marked in Scheme 7.3. Cut to length and use 3x40 black screws to fasten all the corner moldings.

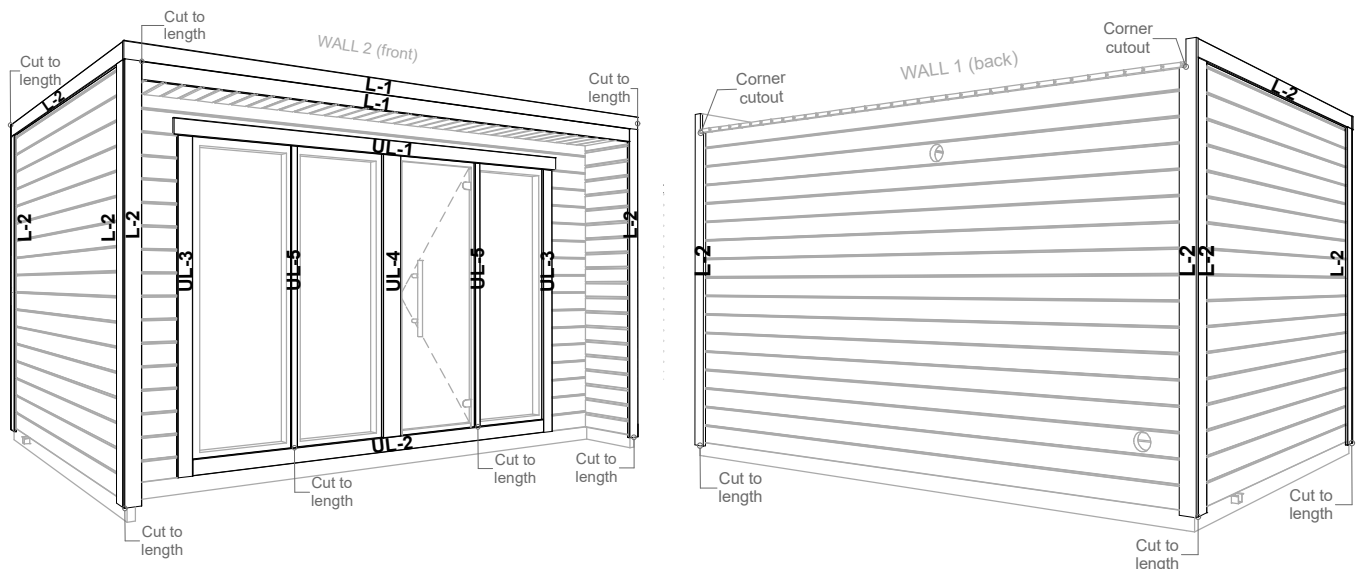

Scheme 7.4

STEP 7 - Outer lining and moldings

7.8 Install the moldings around the door and windows using 3x40 black screws.
For the correct overlay, see Scheme 7.4.

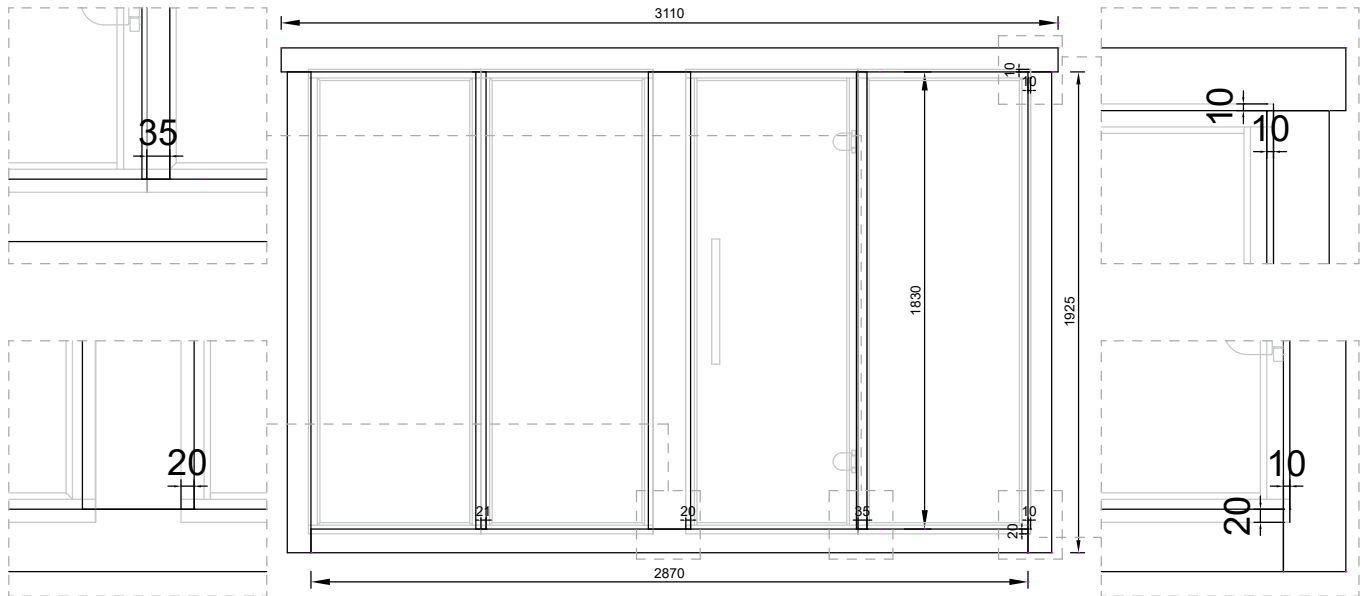

Scheme 7.4

7.9 Paint over all cut ends of the moldings with black Teknos Aqua Primer.
Scan the QR code for more detailed product information.



STEP 8 - Sauna benches

Marking	Detail	Image	Note	Length	Pcs.
	Bench Module 600 mm		Top - Wall A (left)	1793	1
	Bench Module 500 mm		Bottom - Wall A (left)	1793	1
	Bench Module 500 mm		Top - Wall 1 (back)	1320	1
	Bench Module 600 mm		Bottom - Wall 1 (back)	937	1
	Bench Module 500 mm		Anteroom	1911	1
	Bench Skirt			1793	1
	Bench Horizontal Support Set 45x45				1
	Bench Side Frame		Includes 3 adjustable legs		1
	Extra Vertical Support		Includes 1 adjustable legs		1
	Screw 4.5x70		for all supports		100

8.1 Measure the length of the sauna bench and mark the location of the side frame. Adjust the height of the side frame through the adjustable legs. Fix the frame to Wall A (left) using 4.5x70 screws, like shown in Scheme 8.1.

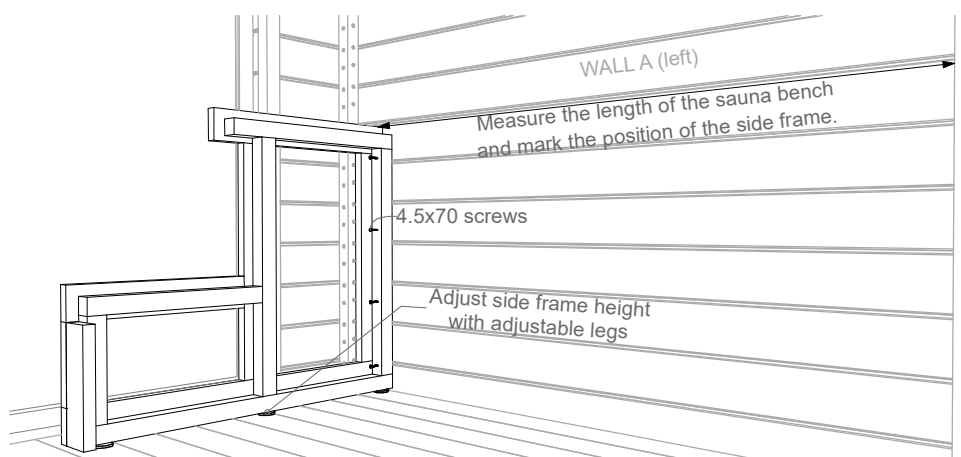
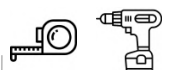

Scheme 8.1

STEP 8 - Sauna benches

8.2 Measure the distance and fix the upper and lower bench supports to the walls in the steam room, according to Scheme 8.2. Use 4.5x70 screws for fixing.

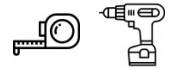

It is recommended to additionally use glue (not included) for fixing the sauna bench supports to the wall.

View from the front:

View from the side:

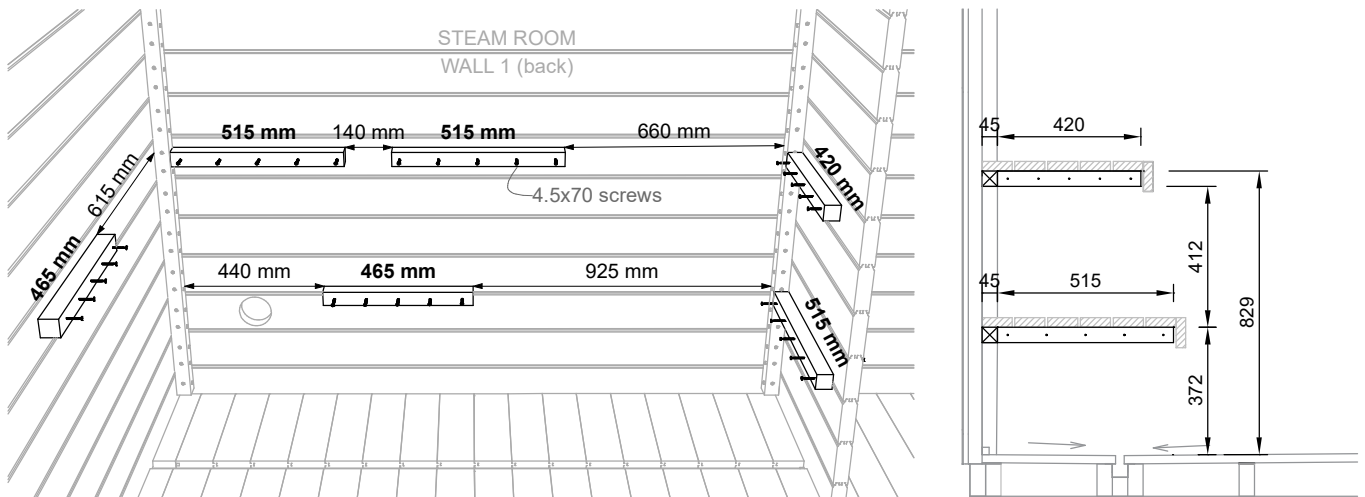

Scheme 8.2

8.3 Lift and place the bottom benches on top of the supports. If LED lighting under the sauna benches has been ordered additionally (not included in the standard set), install the LED strips under the benches before placing them on top of the supports. More detailed instructions are included with the lighting details.

8.4 Set the bench skirt in place. Leave a 8 mm gap between the skirt and the lower bench. Fix the skirt side frames to the side walls and the middle frame to the bottom bench, using 4x70 screws. See Scheme 8.3

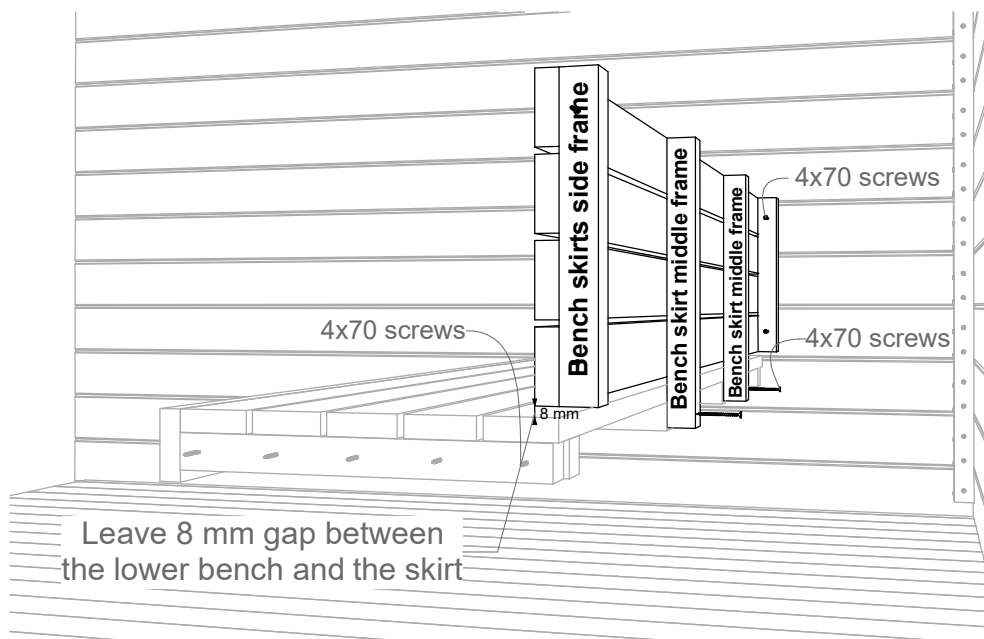

Scheme 8.3

STEP 8 - Sauna benches

- 8.5 Measure the distance and fix the bench supports to the walls in the anteroom, according to Scheme 8.4.
 Use 4.5x70 screws for fixing.
 It is recommended to additionally use glue (not included) for fixing the sauna bench supports to the wall.

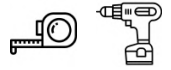

View from the front:

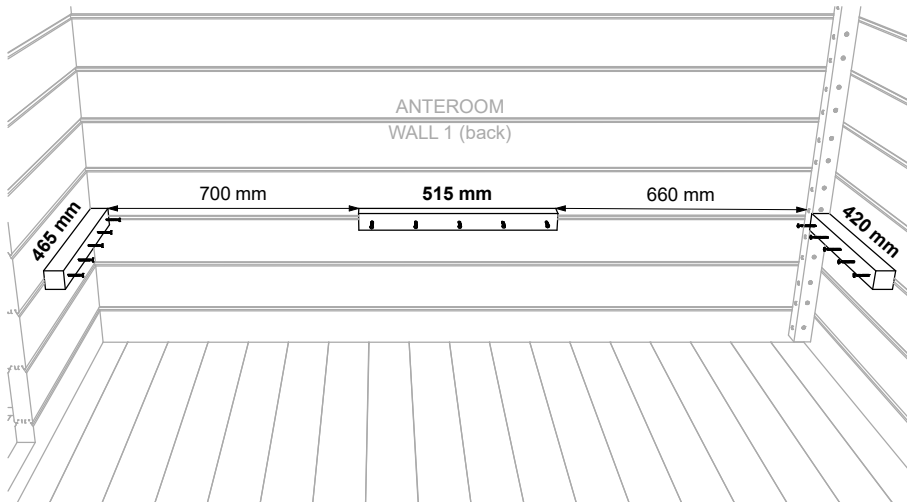

View from the side:

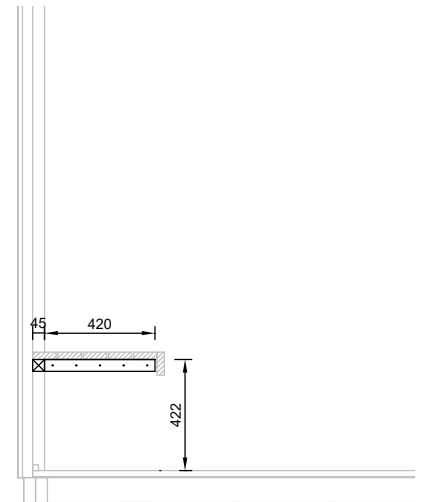

Scheme 8.4

- 8.6 Attach the horizontal support for the back wall benches to the left wall benches using 4.5x70 screws.
- 8.7 Lift and place the benches on top of the supports. Leave ~4 mm gap between the benches and the partition wall. Fix all the benches to the supports through the bench's bottom frame, using 4.5x70 screws. Do not fully tighten the screws. See Scheme 8.5.
- 8.8 If needed, place the extra vertical support under the top benches and fix it in place. Adjust the height of the support through the adjustable leg at the bottom.

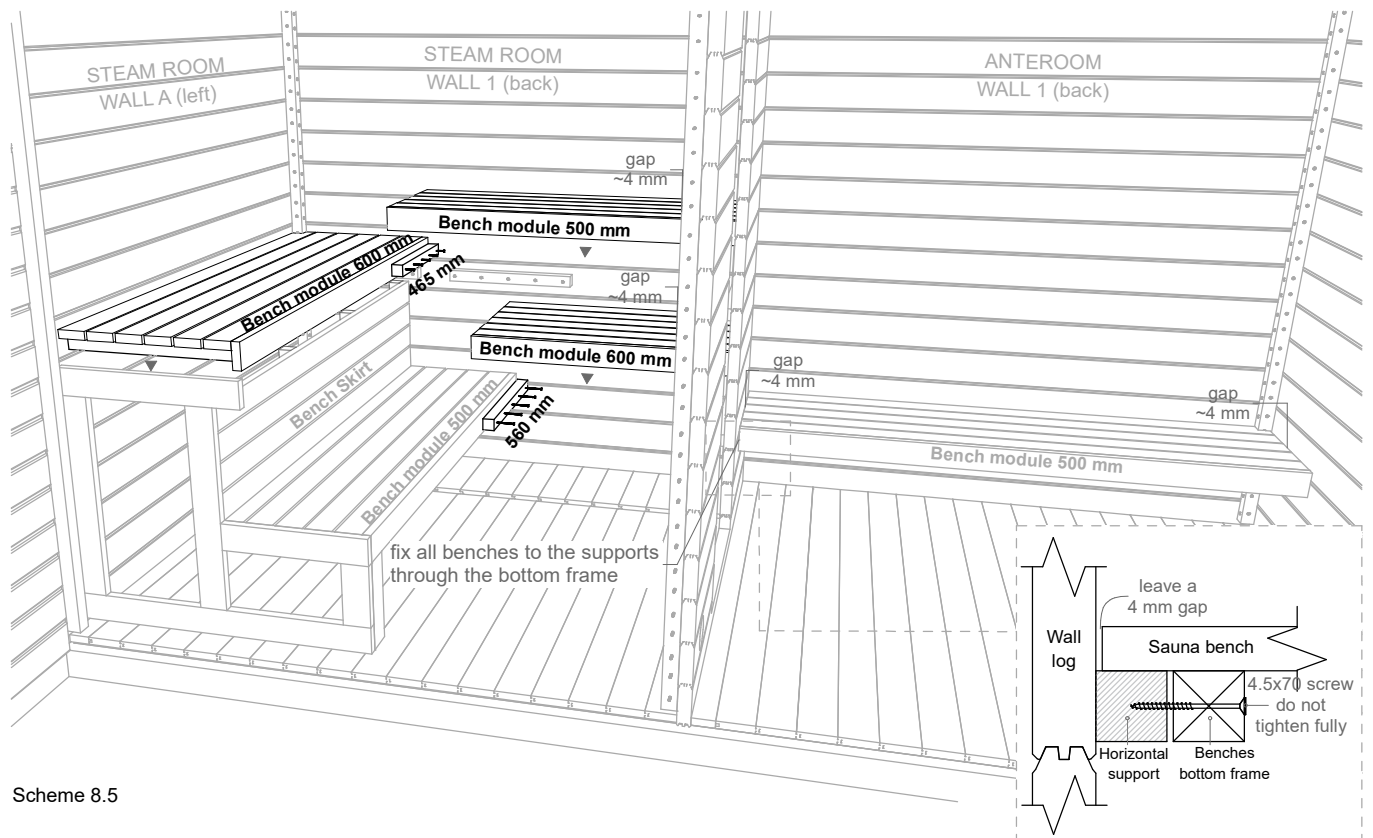

Scheme 8.5

EXTRA: Sauna Backrest (not included in the standard set)

Install the back rest approximately 450 mm higher from the top bench.

Use 4x40 screws to fix the back rest in place and cover the screw heads with wooden cover caps.

It is recommended to additionally use glue to fix the back rest to the wall.

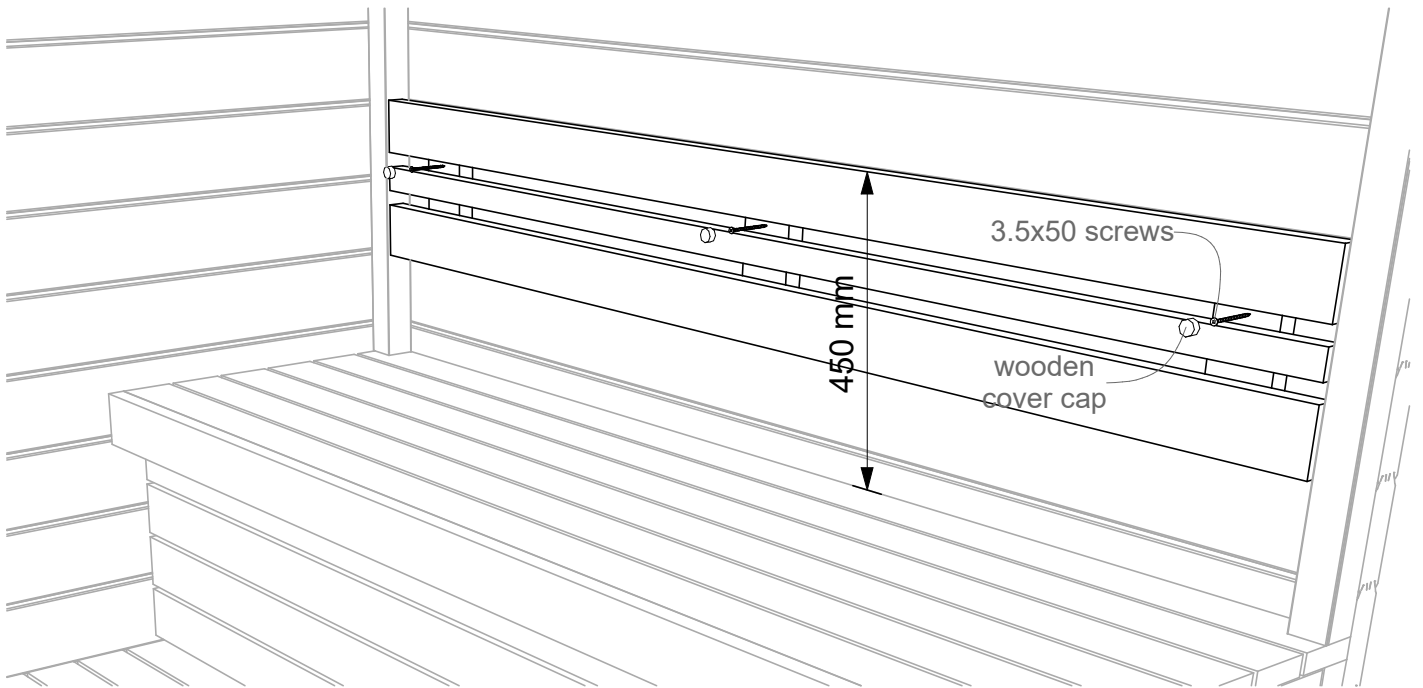
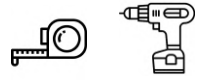

STEP 9 - Interior moldings

Marking	Detail	Image	Note	Length	Pcs.
DI-0	50X50 Corner Post Molding		<i>Cut to length!</i>	2100	5+1
DI-00	21x21 Ceiling and Floor Molding		<i>Cut to length!</i>	2100	14
SL-1	Interior Door Molding			1955	2
SL-2	Interior Door Molding			670	2
VL-1	Exterior Door Molding			1470	1
	40 mm lost-head nail		for all interior moldings		300

9.1 Measure and cut to length all DI-0 corner post moldings with a handsaw.

Install DI-0 corner molding on top of the corner posts, under, between, and above the sauna benches like shown in Scheme 9.1. Fasten the moldings with 40 mm lost-head nails, using a nail gun or a hammer.

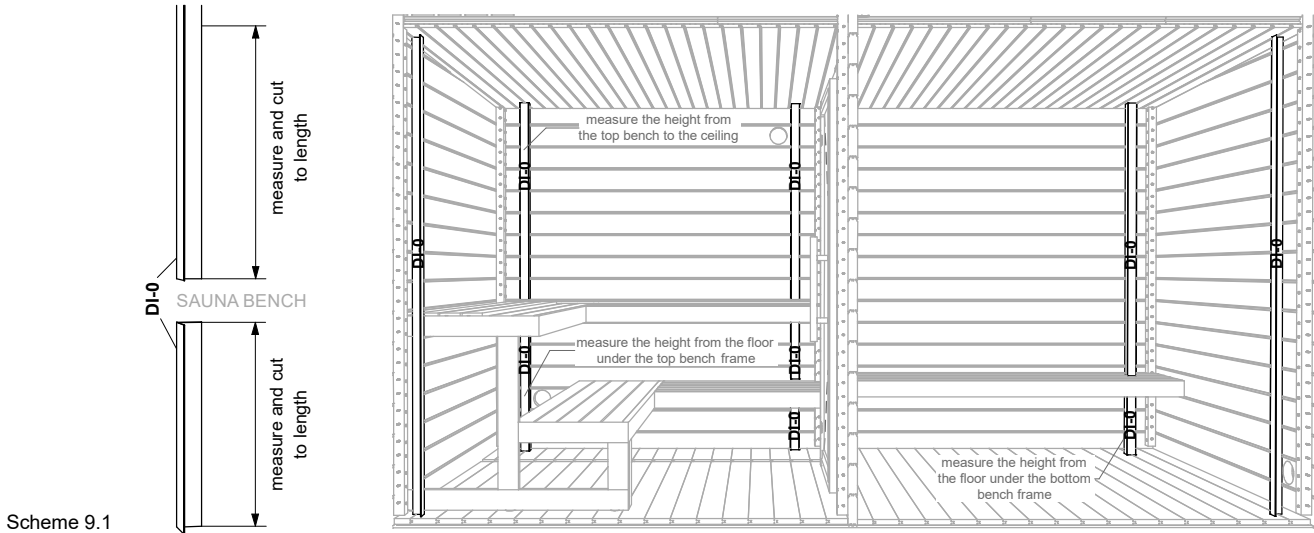

Scheme 9.1

9.2 Install the interior door moldings around the U-2 door in the anteroom with 40 mm lost-head nails. Scheme 9.2.

9.3 Seal the gap under the exterior door with silicone and fasten the VL-1 molding on the inside using 40 mm lost-head nails (Scheme 9.3).



9.4 Measure and cut to length all DI-00 ceiling and floor moldings and fasten them with 40 mm lost-head nails. Use a nailgun or a hammer (Scheme 9.3).

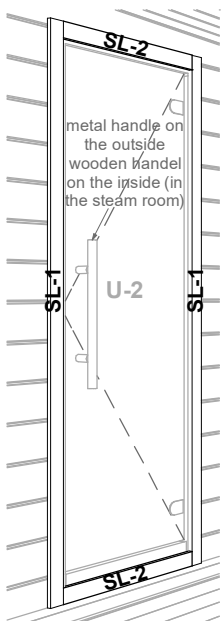



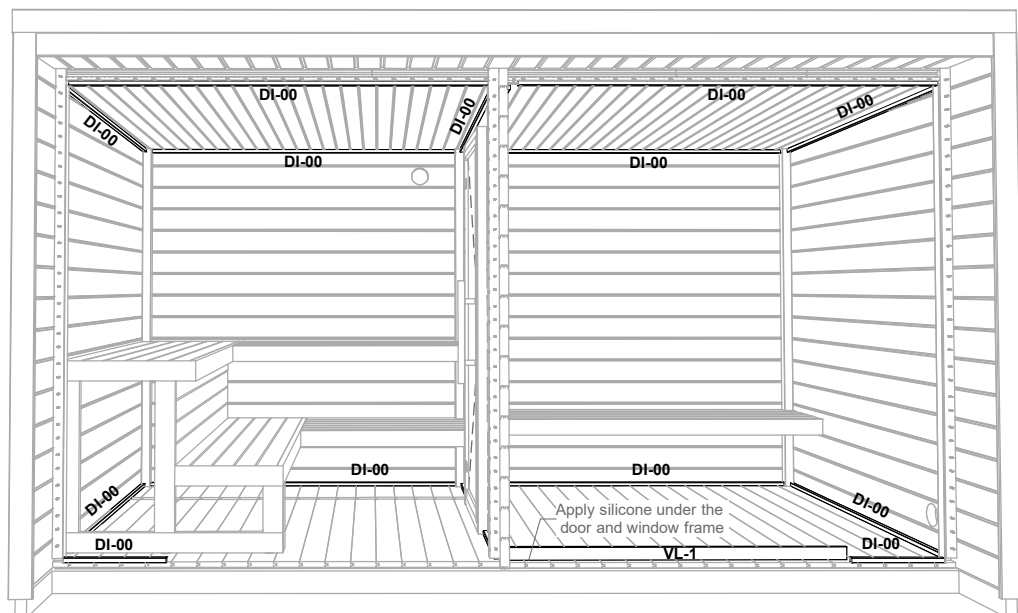

Scheme 9.2



Scheme 9.3

STEP 10 - Roof covering and moldings

Marking	Detail	Image	Note	Length	Pcs.
	EPDM Rubber Roof Cover 4.33x3.05 m				1
	EPDM Glue		2.5 l		2
	EPDM Quickprime		125 ml		1
	Paint roller + Handle				1
	Metal roofing sheet		for back wall <i>Cut to length!</i>	2050 mm	2
	Metal roofing sheet		for front walls. <i>Cut to length!</i> for side walls. <i>Cut to length!</i>	2100 mm 2750 mm	2 2

Marking	Detail	Image	Note	Length	Pcs.
	Black Wronic Screw 4.2x25		for back wall metal roofing sheet		20
	Black Roofing Screw 4.8x25		for side walls metal roofing sheets		35
	Splice Tape		for back wall metal roofing sheet	3.9 m	1

- 10.1 Clean the roof surface from dirt, dust, ice, snow, water, etc.
- 10.2 Cut the back wall metal profile to length with sheet metal scissors. Leave a 1 mm gap on both sides. Attach the back profile to the roof boards on the back wall using 4.2x25 black Wronic screws.
- 10.3 Check the EPDM roof cover for defects before installing. Put the rubber roof cover in position and check for the correct overhang (Image 1).
- 10.4 Fold and roll the rubber roof cover, and start applying the glue to the roof boards and the rubber surface one half at a time. (Image 2). Apply glue in a well-ventilated area. Use gloves, safety goggles, and a respirator.
- 10.5 **Important!** Wait until the glue is "touch dry" (approximately 15 minutes or longer) before folding the rubber in place. Waiting for the glue to dry is necessary to prevent the rubber from bubbling after it is set in place.
- 10.6 Apply Quickprime + glue on top of the back metal profile and rubber. Then apply the double-sided splice tape on top of the metal profile (Scheme 10.1).
- 10.7 Remove the top side of the splice tape and apply the glued rubber on top of the tape. Fold the rubber roof cover in place. Avoid air bubbles and wrinkles on the surface (Image 3).
- 10.8 Smooth the roof cover with a broom or a brush and cut off the excess rubber (Image 4).



Image 1



Image 2

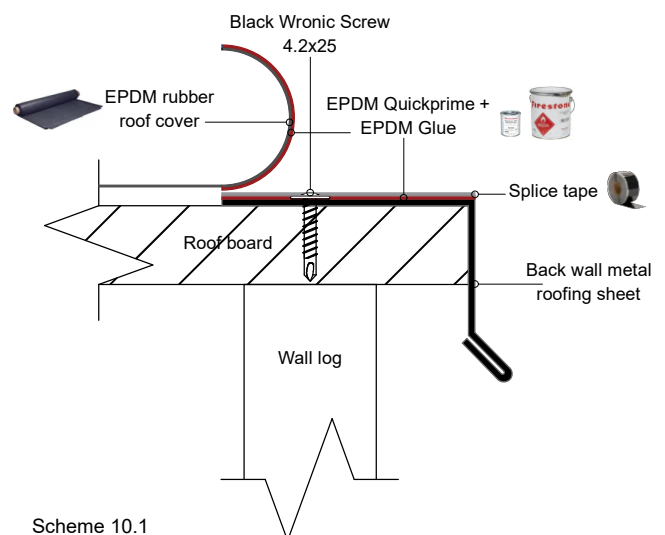

Image 3



Image 4

Back wall metal roofing sheet:



STEP 10 - Roof covering and moldings

10.9 Cut 58 mm off the side metal profiles at one end, like shown in Scheme 10.2. Use sheet metal scissors, pliers and protective gloves to prepare metal roofing sheets for installation.



10.10 Cut 68 mm off the front metal profile at both ends, like shown on Scheme 10.2.

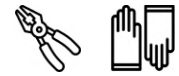

10.11 Fit the front metal roofing sheet on top of the side metal roofing sheets with ends overlapping, like shown in Scheme 10.4.

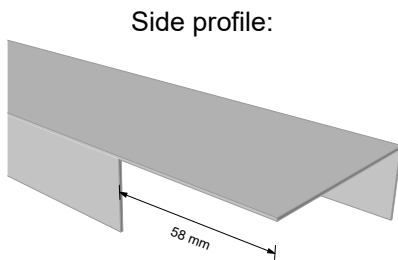

Scheme 10.2

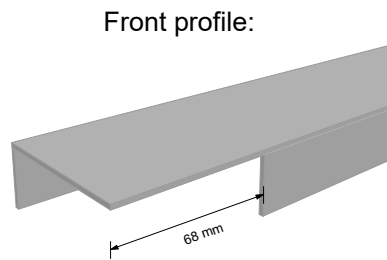

Scheme 10.3

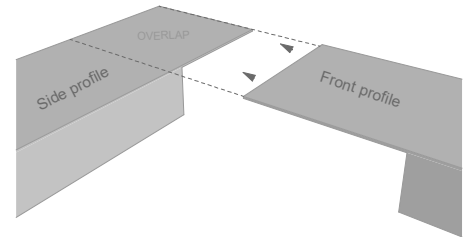

Scheme 10.4

10.12 Use 4.8x25 black roofing screws to fix the profiles to walls at the sides and the roof block at the front (Schemes 10.5 and 10.6).

Front wall metal roofing sheet:

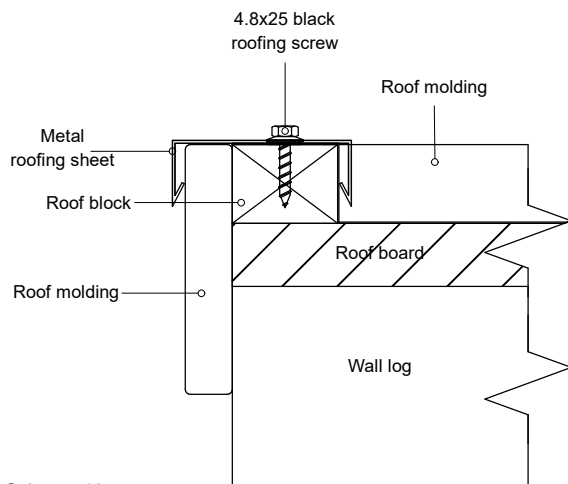

Scheme 10.5

Side wall metal roofing sheet:

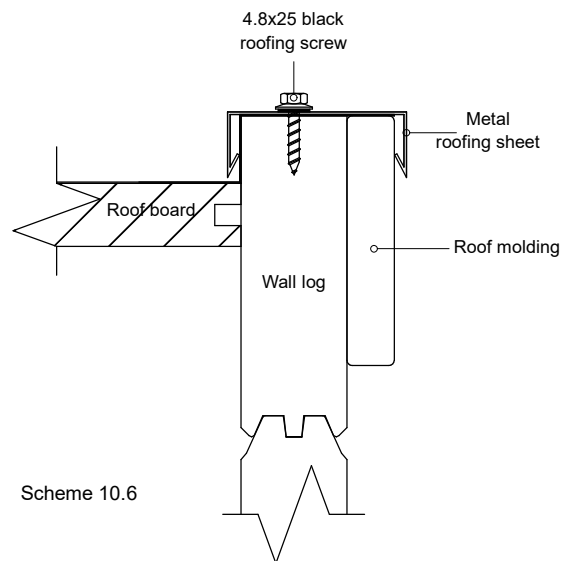

Scheme 10.6

10.13 At the back wall, cut and fold the excess metal roofing sheet 90 degrees downward (Scheme 10.7). Fix with 4.8x25 roofing screws (Image 6).

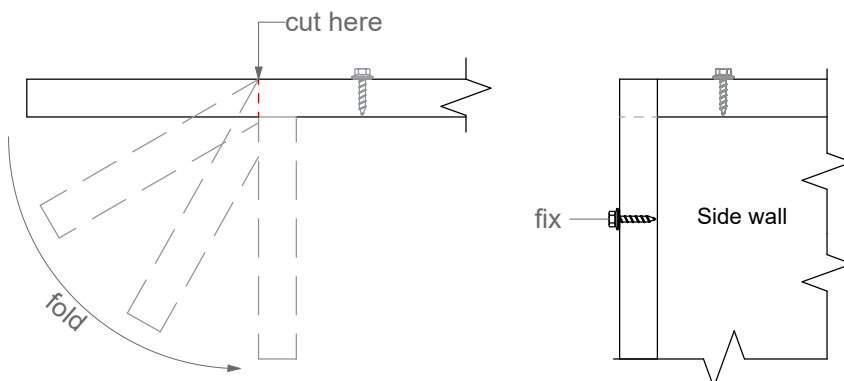

Scheme 10.7

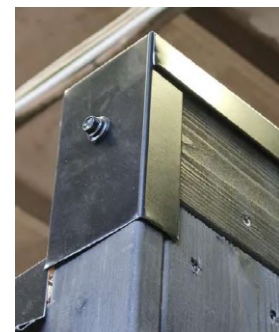

Image 6

Congratulations on a job well done!

You have successfully completed the installation and can soon start enjoying your new sauna.

Before the first use, please read the maintenance and warranty guide and perform the necessary actions.

Maintenance

The interior surfaces of the sauna, the window frames of the steam and anteroom, and the frames of interior doors must be treated with a special substance before initial use, to protect the wood from humidity and dirt and extend the service life of the sauna.

Before initial use of the sauna and once a year after that, the door, doorframe, threshold, and window frames, as well as the floors of the anteroom should be treated with Teknos Helo Aqua 40 lacquer.

The benches and backrests must be treated with a protective oil, to extend their service life. This procedure should be repeated once or twice a year in the future.

Suitable products for this purpose:

- TEKNOS Satu Saunasuojaor
- Tikkurila Supi Saunasuoja May

The exterior surfaces of the sauna need to be given the first protective coating right after installation. The second coating should be applied approximately two months after installing the sauna, to maintain its appearance. Use Remmers HK-Lasur for this purpose.

The substance is available for purchase at Saunasell OÜ or from the website:

<https://trendwood.ee/tooted/viimistlus/remmers/5>.

The seller is not liable for any damage caused to the sauna due to insufficient maintenance or no maintenance at all.

Warranty

The products have a 24-month warranty period covering material and production defects, taking effect from the delivery of the sauna to the client.

The warranty is valid, if the user has reviewed the user manuals and abides by it.

The warranty does not cover characteristics of wood, such as discoloration or cracks caused by alternating or excess humidity, etc.

The warranty does not cover normal wear and tear of the product caused by its use. Any damage caused by incorrect installation or use is not compensated.

The warranty does not cover damage caused by thunder or other weather phenomena.

The warranty does not cover damage caused by incorrect installation by the client.

The warranty expires when attempts are made to independently change or fix the product or if it is not used for its intended purpose.

The warranty is void if the product is stored in an incorrect position or in the wrong conditions.

The warranty is valid if the buyer informs the seller of the defect within a reasonable time (7 days).